

Quechee Gorge Bridge Safety Issues

Suicide Prevention Alternatives

Report to the Vermont Legislature

Prepared by the Vermont Agency of Transportation
With assistance from DuBois & King, Inc.

January 10, 2017

Quechee Gorge Bridge Safety Issues

Suicide Prevention Alternatives

TABLE OF CONTENTS

Executive Summary	iv
Acknowledgements	1
About this Study	2
Study Process	3
The Quechee Gorge Bridge	4
Bridge condition	4
Bridge Cross Section	5
Traffic and Pedestrian Safety	6
Past Bridge Studies	7
Bridge Inspections and Maintenance	8
Quechee Gorge State Park	8
The Quechee Gorge State Park and Bridge Visitor Experience	10
Quechee Gorge Bridge Suicides	14
Rescue and Recovery Operations	17
Means Restriction on Bridges	18
Types of Means Restriction for Bridges	19
Suicide Prevention Barriers	19
Suicide Prevention Nets	22
Cornell/Ithaca Bridge Means Restriction Nets	23
Research on Means Restriction	24
The Duke Ellington Bridge, Washington DC	24
The Memorial Bridge, Augusta, Maine	25
Interviews with survivors and attempters	26
Should means restriction be considered for the Quechee Gorge Bridge?	26
Alternatives	28
1) Do Nothing	28
2) Interventions without means restriction	28
3) Means Restriction via Barrier (balusters)	28

Impacts and Issues	29
4) Means Restriction via Net	30
Impacts and Issues	31
5) Temporary Means Restriction with Wire Mesh Fence	32
Impacts and Issues	32
Potential Project Timeline	33
Potential Impacts of Means Restriction Alternatives	33
Visual Impacts	33
Viewshed Impacts	33
Visual Impact Discussion	38
Cultural Resources	38
Environmental Resources	38
Public Input	39
Project Costs	39
Construction Costs	40
Maintenance Costs	40
VTrans current maintenance costs	40
Town of Hartford costs for rescue/recovery operations	41
Alternative Costs for Maintenance and Operations	41
VTrans Costs for Barrier and Net Alternative	41
Costs to Town of Hartford	42
Mitigation options for Operations and Maintenance challenges	42
Cost Benefit Analysis	43
Analysis of Alternatives	43
Conclusions	45

List of Figures

Figure 1: Existing Cross Section of Route 4 at the Quechee Gorge Bridge	6
Figure 2: Crash Locations on the Quechee Gorge Bridge, US Route 4	7
Figure 3: Month of Crashes on Quechee Gorge Bridge	7
Figure 4: Map of Quechee Gorge State Park	8
Figure 5: Annual visitors at Vermont's State Parks with the highest day use	9
Figure 6: Quechee Gorge suicides by year (2003 – present)	15
Figure 7: Month of death at Quechee Gorge suicides	16
Figure 8: Age and Gender of Quechee Gorge suicides (2003 – present)	16
Figure 9: Quechee Gorge bridge ages of death compared to statewide suicide	17
Figure 10: Suicide prevention nets on Muenster Terrace Bridge in Bern, Switzerland	22
Figure 11: Location of Duke Ellington and Taft Bridges, Washington DC	24
Figure 12: Annual suicide rate on Duke Ellington and Taft Bridges, and regionally*	25
Figure 13: Means Restriction Barrier Cross Section	29
Figure 14: Suicide Prevention Net Cross Section	30
Figure 15: Example of temporary wire mesh barrier from Ithaca, NY	32
Figure 16: Viewshed Impacts from Barrier and Nets	34

List of Tables

Table 1: Cost Summary for Means Restriction Alternatives	39
Table 2: Annual Maintenance and Inspection costs for VTrans	40
Table 3: Projected annual maintenance and operations costs for barrier alternative	42
Table 4: Alternatives Decision Matrix	44

Appendix (Volume 2)

- 1) Text of relevant portions of 2016 Transportation Bill
- 2) Resource reviews (checklist, historical, archaeological, environmental)
- 3) Public meeting notes and presentation
- 4) TAC meeting notes
- 5) Cost estimates

Executive Summary

This study has been initiated by the Vermont Agency of Transportation following legislation passed in the 2016 session (Section 38. Quechee Gorge Bridge Safety Issues as identified in the 2016 Transportation Bill). The purpose of this study is to review suicide prevention alternatives as well as pedestrian, first responder, and other safety measures that could be taken, and the merits of taking such measures, at the Quechee Gorge Bridge.

Quechee Gorge State Park is by far the most visited state park in Vermont, and many additional visitors enjoy the spectacular views from the historic Quechee Gorge Bridge. It provides enjoyment and inspiration to visitors from across the world, of all ages and backgrounds .

The Quechee Gorge Bridge has been the site of 15 suicides since 2003, about one per year on average. These tragic events tend to coincide with the season of peak visitation to the bridge and gorge; though most often not during daylight hours. The age of those attempting suicide at Quechee Gorge Bridge is younger than the statewide average suicide age. There have also been numerous interventions by the Hartford Police Department that have successfully thwarted additional suicide attempts.

Means restriction on bridges, in the form of suicide prevention barriers or nets, have been widely used on bridges that are the sites of repeated suicides. Research on the effectiveness of means restriction on bridges shows that suicides can be prevented, and there is no evidence of means restriction leading distraught people in crisis to instead use other means of suicide or visit alternative sites with lethal heights.

Based on a conceptual design assessment, means restriction options including barriers or nets would each cost about \$2 million for construction, and would also impose additional maintenance costs. The ongoing maintenance costs is higher for the nets than for a barrier due to the requirement for annual inspection and repair of the nets.

The impacts of means restriction include impacts to historic and natural resources, and visual impacts that would affect the enjoyment of the park and potentially the area economy. An initial review by historic resources staff at VTrans indicates that neither of the means restriction options is expected to impact the historic characteristics of the bridge.

Quechee Gorge Bridge Safety Issues

Suicide Prevention Alternatives

Acknowledgements

The following people were instrumental in providing input and guidance during the preparation of this study.

- **Technical Advisory Committee members**

Dr. Jaskanwar Batra, Vermont Department of Mental Health
Michele Boomhower, Vermont Agency of Transportation
Jennifer Chambers, Healthcare and Rehabilitation Services of Vermont
Devin Colman, Vermont Agency of Commerce and Community Development
Jesse Devlin, Vermont Agency of Transportation
Judith Ehrlich, Vermont Agency of Transportation
Peter Gregory, Two Rivers Ottauquechee Regional Commission
Karl Hakala, United States Army Corps of Engineers
Whitney Hussong, Town of Hartford Police Department
Chief Phillip Kasten, Town of Hartford Police Department
Todd Law, Vermont Agency of Transportation
J.B. McCarthy, Vermont Agency of Transportation
Heather Morse, United States Army Corps of Engineers
Kyle Obenauer, Vermont Agency of Transportation
Ethan Phelps, Vermont Department of Forests, Parks, and Recreation

- **Additional Vermont Agency of Transportation staff**

Chris Bump, Southeast Region District 4 Project Manager
Jon Kaplan, Bicycle & Pedestrian Program
Kevin Marshia, Director of Highway Division
Chris Slesar, Environmental Resources Coordinator
Pam Thurber, NBIS Inspections & Budget Program Manager
Wayne Symonds, Project Delivery Bureau Structures Program Manager

- **Additional/local stakeholders**

Alan Beebe, Town of Hartford Assistant Fire Chief
Representative Alison Clarkson
Chief Scott Cooney, Town of Hartford Fire Chief
Regina-Anne and Dave Cooper, Local Residents and Advocates
Scott Farnsworth, Hartford Community Coalition
Lori Hirshfield, Town of Hartford Planning Director
Kip Miller, Local Business Owner

Gary Neil, Local Business Owner
Leo Pullar, Town of Hartford Town Manager
Allyn Ricker, Town of Hartford Highway Superintendent
PJ Skehan, Hartford Area Chamber of Commerce

- **Consultants (D&K + VSPC)**

Lucy Gibson, PE, DuBois & King
Robert Durfee, PE, DuBois & King
Monika Quinn, EI, DuBois & King
Sophie Sauve, ASLA, DuBois & King
Dr. JoEllen Tarallo- Falk, Center for Health and Learning & Vermont Suicide Prevention Center

- **Others that provided information used in this study**

Tom Parsons, Ithaca NY Chief of the Fire Department
John Keefe, Facilities Manager, Cornell University
Dr. Gregory Eells, Cornell University
Paul Muller, Bridge Rail Foundation
Kathy Zoner, Cornell University Police Chief
Lauren Signer, Ithaca NY Chief of Police
Thomas Delaney, PhD., Vermont Child Health Improvement Program, University of Vermont

About this Study

This study has been initiated by the Vermont Agency of Transportation following legislation passed in the 2016 session (Section 38. Quechee Gorge Bridge Safety Issues as identified in the 2016 Transportation Bill). The purpose of this study is to thoroughly review suicide prevention as well as pedestrian, first responder, and other safety measures that could be taken, and the merits of taking such measures, at the Quechee Gorge Bridge. In addition, the Transportation Bill stipulates that the review will identify:

1. short- and long-term suicide prevention as well as pedestrian, first responder, and other safety measures for all users that could be taken, including:
 - a) providing information and resources, including emergency contact information and means of emergency communication; and
 - b) physical improvements to the bridge structure and the surrounding area;
2. estimated costs and benefits and an expected timeline associated with implementing the measures identified in subdivision (1) of this subsection; and
3. economic, community, and tourism concerns associated with implementing the measures identified in subdivision (1) of this subsection.

Study Process

The approach to this study was primarily guided by the legislation, and included the following components:

Project Scope: The scope of this study included gathering information on means restriction, assessing site conditions and use, and preparing this report that identifies options for means restriction, and related costs, impacts and issues, for consideration of the Vermont Legislature. The report also includes a possible project time for implementation and phasing. The study process included developing alternatives, and refinement of those alternatives based on input from VTrans and other stakeholders. The visual and environmental impacts, maintenance requirements and costs, and design considerations are also described.

Literature Review/Case Studies: The study team reviewed bridge means restriction literature and case studies to determine options for means restriction that would be both effective and compatible with the site conditions of Quechee Gorge, and identified non-means restriction measures such as signage or lighting that could potentially be employed.

Site Visits/Data Collection: Quechee Gorge is truly a unique place, and the bridge is an exceptional scenic and historic resource. The study team conducted several site visits to assess the bridge and its environs, and issues related to means restriction. In addition, the project team's landscape architect conducted observations on how visitors use and enjoy the bridge and nearby trails to inform the assessment of visual impacts of means restriction options. Vehicular and pedestrian traffic and safety was also considered. The project team reviewed data on deaths at the Gorge, data on interventions with individuals in crisis, and local recovery operation procedures.

Community and Stakeholder Engagement: The Transportation Bill stipulated that VTrans would consult with the following: the Agency of Commerce and Community Development; the Department of Health; the Department of Mental Health; the Department of Public Safety; local officials; local emergency personnel; the Hartford Area Chamber of Commerce; mental health practitioners; local business owners; and other interested stakeholders. In order to accomplish this task, a comprehensive outreach and engagement strategy was developed. The VTrans project manager and the consulting team vetted each phase of the study primarily through a Technical Advisory Committee that consisted of representatives as identified in the Transportation Bill. In addition, targeted outreach was conducted across Agency disciplines for directed input. Finally, both a Local Officials meeting and a Public meeting were conducted in Hartford to review the proposed alternatives and solicit feedback. Comments were taken on the study for 30 days post public meeting.

The Quechee Gorge Bridge

The Quechee Gorge Bridge was originally constructed in 1911 as a railroad bridge on the line connecting Woodstock to White River Junction. The bridge span is 285 feet across Quechee Gorge, with the Ottauquechee River 165 feet below the bridge. After the railroad was discontinued, and Vermont's highway system grew, US Route 4 was relocated from Quechee Village to use the former railroad bridge in the 1930's. US Route 4 is a principal arterial, and the primary east-west route across the central part of Vermont. The most recent vehicle counts show about 9,000 vehicles per day use the bridge, and nearly 1,000 are trucks.

Bridge condition

This bridge was last inspected on May 22, 2015. The condition rating on the deck at that time was "good." The condition rating on the superstructure is "fair." The concerns with the superstructure that were noted included deteriorated bridge joints, and lattice plates and gusset plates that are in need of reinforcing. The need for the structural steel to be cleaned and painted was also mentioned. There is approach rail and some bridge rail in needs of replacement. The rating for the substructure is "satisfactory." Comments were included in the inspection report about a shale slope that needs stabilizing, as stone from this slope is falling onto the structure. The channel rating is "very good" and it is considered to be stable for scour. Overall, the bridge is in good condition considering its age, and is currently inspected every other year, which itself is an indicator of its sound condition. When one or more component of the



bridge is downgraded to poor condition due to deterioration or other factors, it will be move to an annual inspection process.

Bridge Cross Section

The Quechee Gorge Bridge carries US Route 4, with two 12 foot travel lanes, 3 foot shoulders on each side, curbing, and with sidewalks extended beyond the shoulders. There are removable pedestrian barriers between the road shoulder and sidewalk, which provide protection for pedestrians during the non-winter months. During the winter, the barriers are removed, allowing for VTrans to periodically remove snow from the sidewalks, typically two or three times each winter depending on snowfall. There is a crash-tested vehicle rail on the outside of each sidewalk, and a clear pedestrian traveled way of 3 foot 6 inches wide. The sidewalks were added to the bridge in 1972 by cantilevering the steel floorbeams beyond the existing steel bridge structure. There is a Town of Hartford water line mounted on the bridge under the north side sidewalk.

Figure 1: Existing Cross Section of Route 4 at the Quechee Gorge Bridge

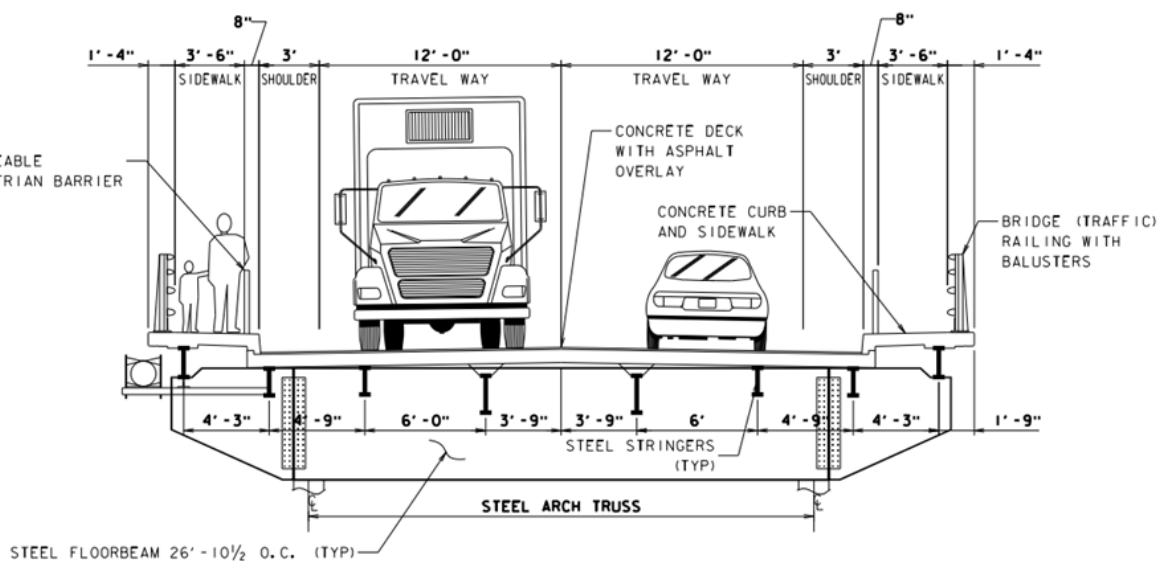

The Vermont State Design Standards state that, “Bridges to remain in place without treatment should have at least the width of the roadway approach travel way plus 2-foot clearance to face of rail on each side, and should be adequate for State legal loads without posted restrictions.” In terms of bridge width, the Quechee Gorge Bridge exceeds this standard, with 3-foot shoulders on either side.

VTrans publishes *Highway Safety Design Engineering Instructions* to provide specific guidance on important design criteria. Several of these items are applicable to the Quechee Gorge Bridge:

HSDEI 11 - 004: The recommended minimum width of pavement . . . is defined as the distance between the roadway centerline and the edge of paved shoulder or obstruction. An obstruction may include curbing, on-street parking, sidewalk bulb-outs, etc. All VTrans-maintained roadways should have a minimum width of pavement of 14 (fourteen) feet for all directions of travel. Note that this is a recommended minimum width and if the “Vermont State Standards” indicate that wider lanes and shoulders are required based on specific roadway characteristics, that width shall govern.

HSDEI 15 - 103: The lane width is defined as the distance between the center of the roadway (center of the centerline) and the edge of traveled way (center of edgeline). Vermont state highways should have a maximum lane width of 11 (eleven) feet for all directions of travel. Note that this is a recommended maximum width and if the “Vermont State Standards” indicate that wider lane widths are required based on specific roadway characteristics, that width shall govern. When 11 (eleven) foot lanes results in a decrease in lane width the shoulder width shall be increased resulting in no change in the overall paved roadway width.

The above guidelines suggest that the travel lanes on the Quechee Gorge Bridge could be narrowed from the existing 12 foot width to 11 foot lanes, and that, if 3 foot shoulders are provided, the width will meet the minimum required for safe snow removal.

The bridge does not comply with Public Right-of-Way Accessibility Guidelines (PROWAG – a.k.a. Americans with Disabilities Act standards) because of its narrow sidewalks. In order to meet these guidelines, the sidewalk should be a minimum of 4 feet wide with passing zones of at least 5 feet wide provided every 200 feet. The existing sidewalk provides only a 3 feet 6 inch sidewalk over the span of the bridge, which is 285 feet.

There are no VTrans projects planned for the Quechee Gorge Bridge, but eventually a rehabilitation is likely to be planned. Any project that included replacing the bridge rails or work on the bridge deck is likely to require widening the sidewalks to comply with ADA regulations.

Traffic and Pedestrian Safety

The VTrans crash database indicates that there have been 22 crashes on bridge between 1/1/2010 and 10/5/2016. All of these were rear end collisions, and four of which involved injuries. This data, combined with the team’s observations, suggests that the crashes primarily involve stopped vehicles that are either viewing the gorge or yielding to crossing pedestrians.

Figure 2: Crash Locations on the Quechee Gorge Bridge, US Route 4



The seasonal patterns of the crashes strongly correlates to the tourist season, with July being the peak month for crashes.

Figure 3: Month of Crashes on Quechee Gorge Bridge

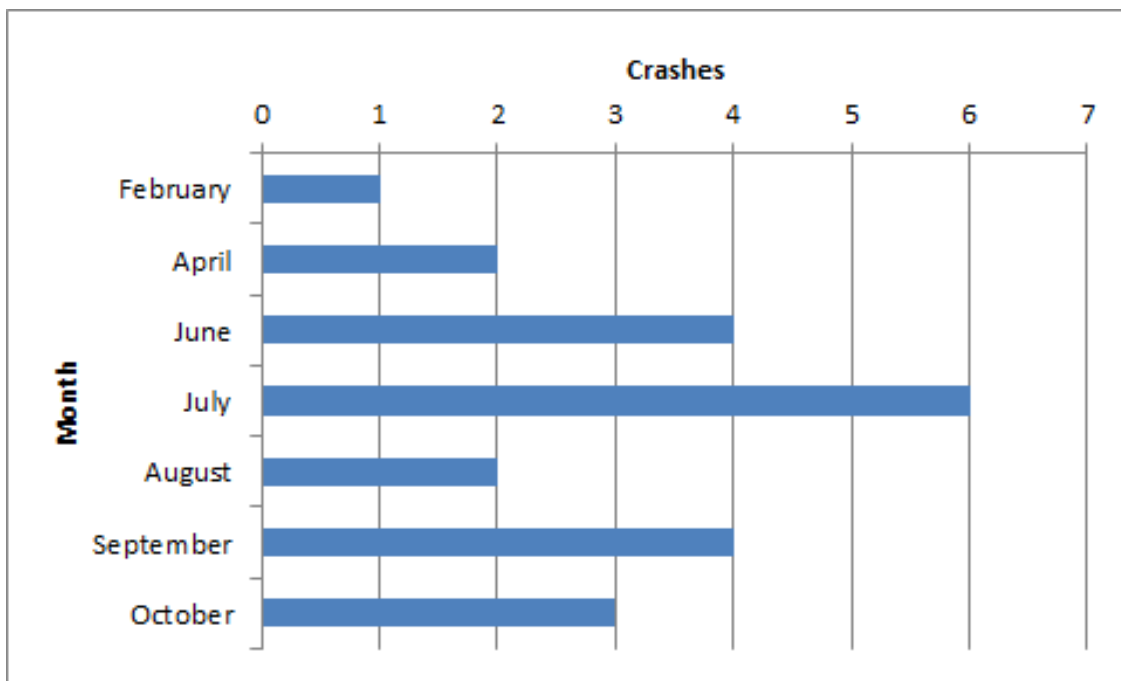

Past Bridge Studies

In 2002, the Town of Hartford worked with VTrans on the Quechee Gorge Bridge & Pedestrian Analysis, which explored options to enhance pedestrian and traffic safety on and around the bridge. The primary concern was to address the safety of the uncontrolled pedestrian crossings and substandard sidewalks on the bridge. Alternatives included providing mid-span viewing areas that would widen the pedestrian traveled way to meet ADA, providing stairs at either end of

the bridge to allow pedestrians to cross US 4 under the bridge and alleviate conflicts due to at-grade crossings, and providing overlooks that would be an alternative to viewing the gorge from the bridge. While none of these alternatives were advanced, VTrans did upgrade the pedestrian crossing signs to incorporate flashing lights when activated by a pedestrian.

Bridge Inspections and Maintenance

Currently, the bridge is inspected with a snooper truck that pulls onto the sidewalk to allow access under the bridge. Annual bridge maintenance practices include bridge washing, installing the pedestrian barriers in the spring, and removing in the fall. The sidewalks are not plowed, but used as snow storage, and snow is periodically removed from the bridge by VTrans. The costs of these activities are provided later in the report.

Quechee Gorge State Park

Quechee Gorge State Park (shown in white in Figure 4) has trails, picnic areas, a campground and a visitor center, but the Quechee Gorge Bridge is the centerpiece. There are a number of tourist related businesses adjacent to the park on the north side of US 4. The land is owned by the US Army Corps of Engineers, and is part of the North Hartland Lake Recreation Area, which extends down the Ottauquechee River to the North Hartland dam.

Figure 4: Map of Quechee Gorge State Park

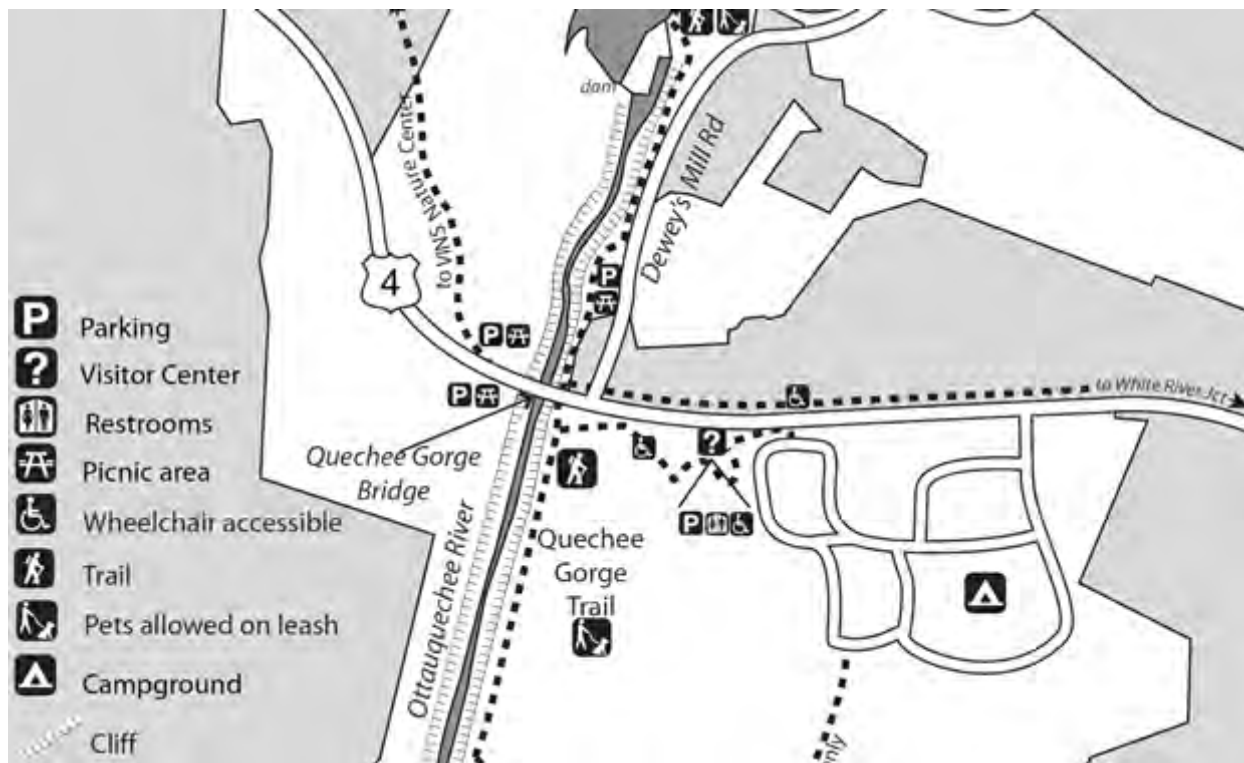

While the specific number of total visitors to the bridge is not known, visitor count information for the park is as follows:

- 100,000 visitors per year at the Quechee Gorge State Park Visitor Center
- Many additional people visit the bridge without checking into the Visitor Center
- 30,000 per year use the trails from the Visitor Center,
- Many additional people enter trails from the Quechee Gorge Gifts parking area

Based on the above Visitor Center statistics, Quechee Gorge State Park has by far the most visitors of any state park in Vermont, as shown in Figure 5.

Figure 5: Annual visitors at Vermont’s State Parks with the highest day use

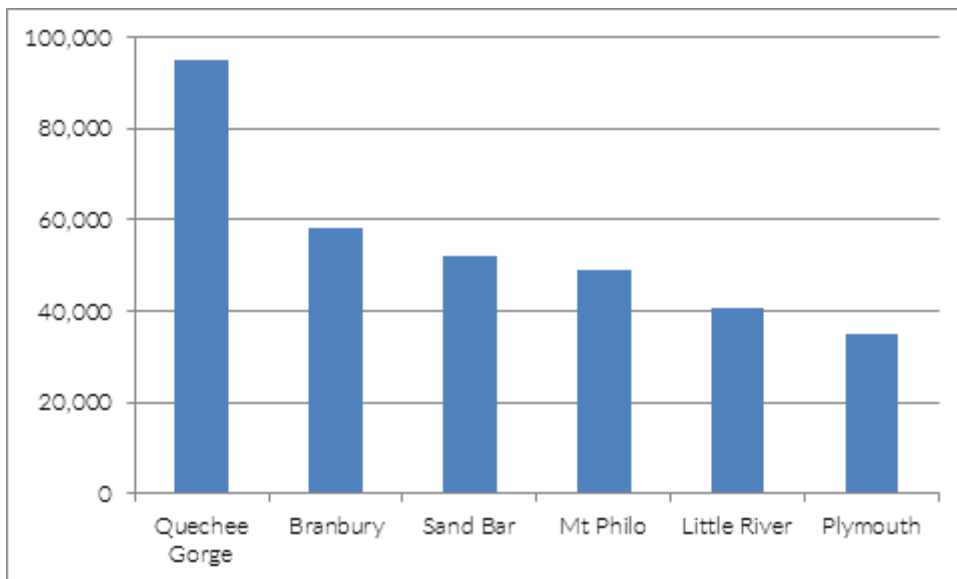

The photos below show scenes from the trail around the Quechee Gorge Bridge. A four foot chain link fence is provided along the top of the gorge cliffs, maintained by Vermont State Parks.

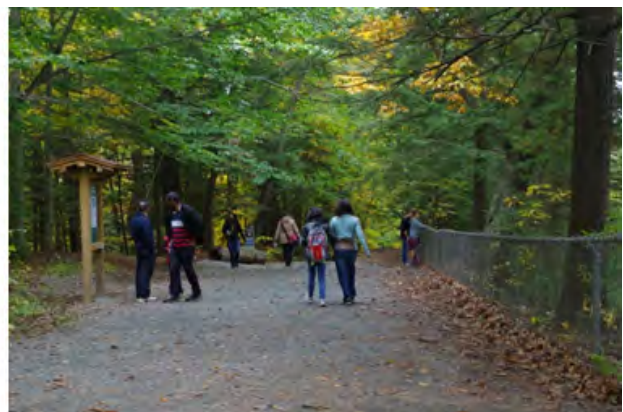



The Quechee Gorge State Park and Bridge Visitor Experience

Observations were conducted on Saturday, October 2 and Saturday, October 9, 2016, to assess visitor patterns and viewing behavior. The following summarize the initial findings:

- Very large numbers of visitors are constantly streaming across the bridge on both sides, even in rainy weather.
- Nearly equal viewing occurs on both sides of bridge.
- Sidewalks are too narrow to accommodate the number of visitors; as well as visitors with a stroller, walker or wheelchair.
- Frequent pedestrian crossings of US Route 4 result in traffic queues.

From these observations, it is clear that the current bridge configuration results in programmatic conflicts due to the overcrowded sidewalks, especially if any visitors have strollers, walkers, use wheelchairs, or are walking dogs. Occasionally, visitors were observed hopping over the pedestrian barrier and entering the traveled lane to photograph their companions, as the narrow sidewalks constrain group picture taking.

The following photographs provide a sampling of how the crowds of people experience and enjoy Quechee Gorge from the bridge. Viewing patterns include looking straight down into the gorge, viewing the gorge landscape, and taking photos of both the landscape and “selfies” with the landscape in the background. There are spectacular views on both sides of the bridge, and the typical visitor circulation pattern is to walk to the bridge from the parking area, cross the bridge on one side of the road, and then cross US Route 4 and view from the other side of the bridge while returning to their car. Many visitors only stop at the bridge and do not continue to the trails or visitor center. All of the following photos were taken on Saturday, October 2 and Saturday, October 9, 2016, which provide a portrait of how people experience the bridge.

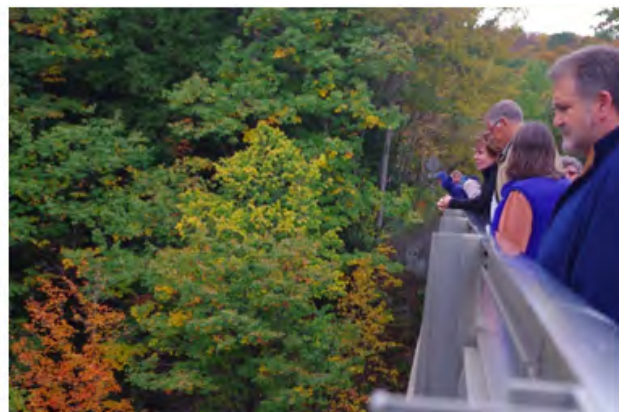

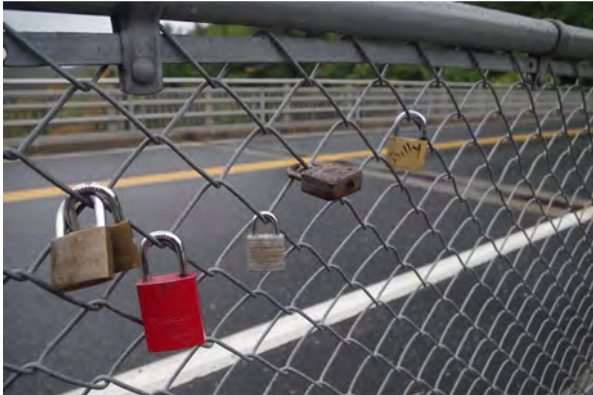

The photos below show views from the north side of the bridge (left) and the south side of the bridge (right).

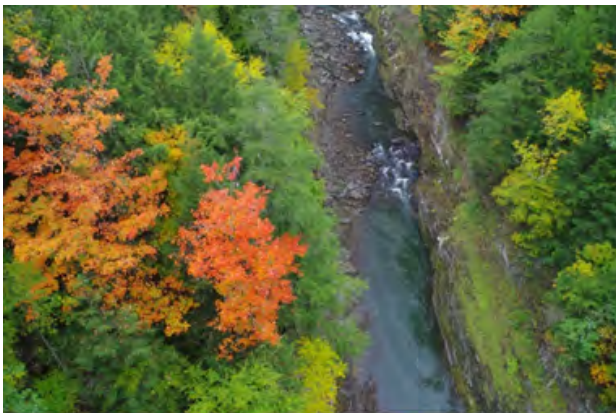

The trail under the bridge also provide dramatic views of the bridge itself.



Quechee Gorge and the bridge are treasured, scenic places where people from all over the world stop to visit and enjoy a breathtaking view from a stunning historic bridge. It provides a beautiful and inspiring experience and is one of relatively few locations that provide dramatic natural views from a location that is easily accessible for most people. It is also an area of economic activity, as many extend their visit to include stopping at stores, dining in restaurants or staying in lodging at Quechee Gorge Village.

Quechee Gorge Bridge Suicides

The following summarizes the recent data on bridge suicides at the Quechee Gorge bridge.

- On average there has been 1 suicide per year over the past 13 years. Data prior to 2003 is not available, but anecdotal reports suggest that this recent history is the continuation of a long standing pattern. There have been 2 suicides per year in the past 2 years.
- Between 2007 and 2016, there have been 19 incidents where the Hartford Police intervened to help a person on the bridge appearing to be contemplating or threatening suicide. In addition, one individual threatening to jump was rescued from the cliffs adjacent to the bridge.

- The Hartford Police have reports of 35 cases of individuals who threatened to go to the Quechee Gorge bridge either verbally or through social media from 2007 to 2016.
- The majority of suicide deaths occur during evening, night or early morning hours, though several have occurred during daylight when visitors are in the area.
- There were 911 total suicides in the state of Vermont between July 1, 2008 and December 28, 2016¹. During this period, there were 9 deaths by jumping at the Quechee Gorge Bridge, and 2 deaths by jumping or falling at other bridges in the state of Vermont.

The bridge has become associated with a long record of suicides. This reputation, combined with a relatively low and easily climbable barrier, may draw people to the bridge during times of crisis.

The chart below shows the incidence of suicides from 2003 to the present.

Figure 6: Quechee Gorge suicides by year (2003 – present)

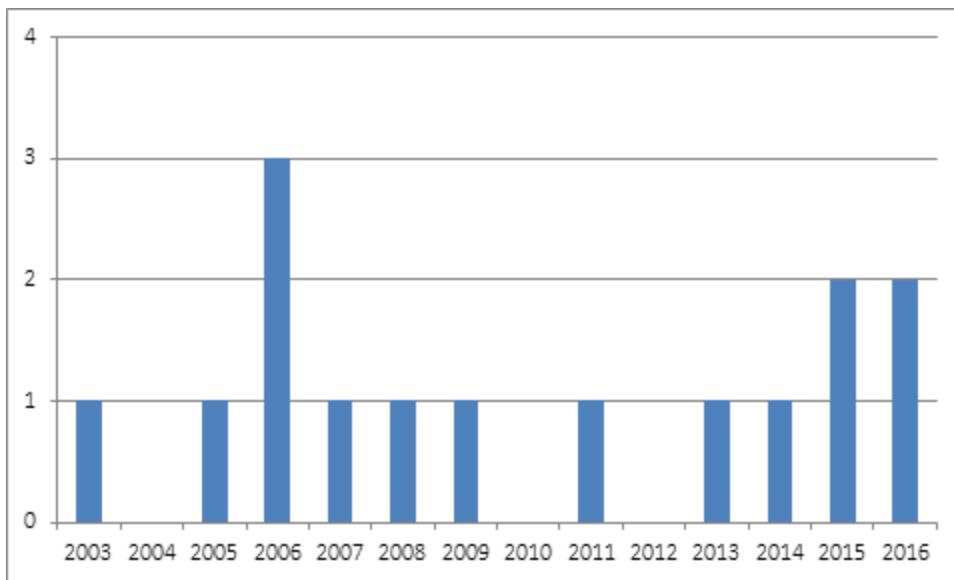

A review of the general literature published on the topic of jumping related to transportation infrastructure suggests there is not agreement in the literature about a threshold for action, or a number or interval associated with a preferred site. Clusters have been reported to exist with as little as two events, and many sites are assessed on 5 year intervals in the literature. Suicide prevention barriers have been installed on many bridges with lower suicide rates than at Quechee Gorge.

¹ Source: VT Department of Health Vital Statistics System, December 28, 2016

The seasonal distribution follows widely observed patterns of suicides peaking in the month of May, and are more prevalent from May to September. The high number of people that visit the Quechee Gorge Bridge and surrounding area during these same months makes the impact of the incidents on witnesses and the community much more traumatic.

Figure 7: Month of death at Quechee Gorge suicides

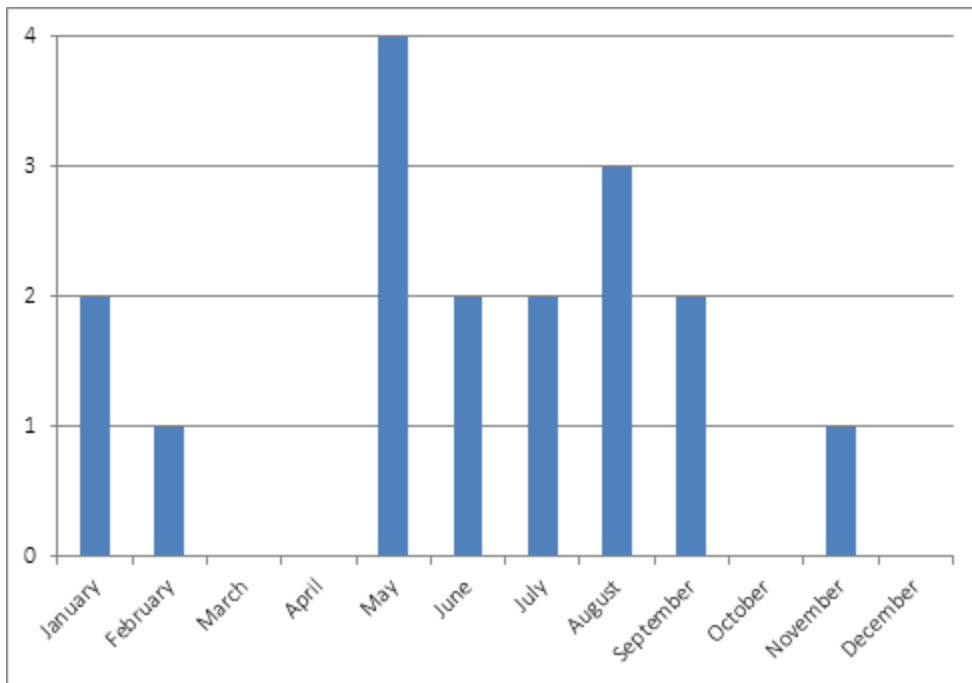

The chart below shows the age and gender of suicide completions at the Quechee Gorge Bridge.

Figure 8: Age and Gender of Quechee Gorge suicides (2003 – present)

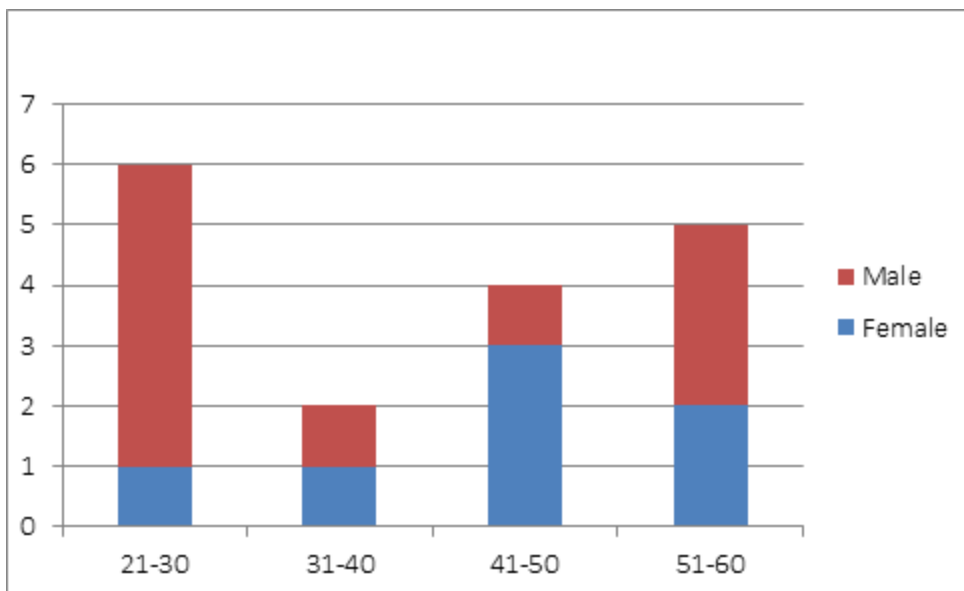

The age range of Quechee Gorge suicide deaths is highest between 21 and 30; with the next highest age range of 51 to 60. UVM researchers contributed the following chart, showing the Quechee Gorge ages of death compared to the statewide suicide deaths, and shows much higher incidence in the age range of 21-30 than would be expected by the overall suicide age distribution.

Figure 9: Quechee Gorge bridge ages of death compared to statewide suicide age distribution (source VT Child Health Improvement Program, UVM)

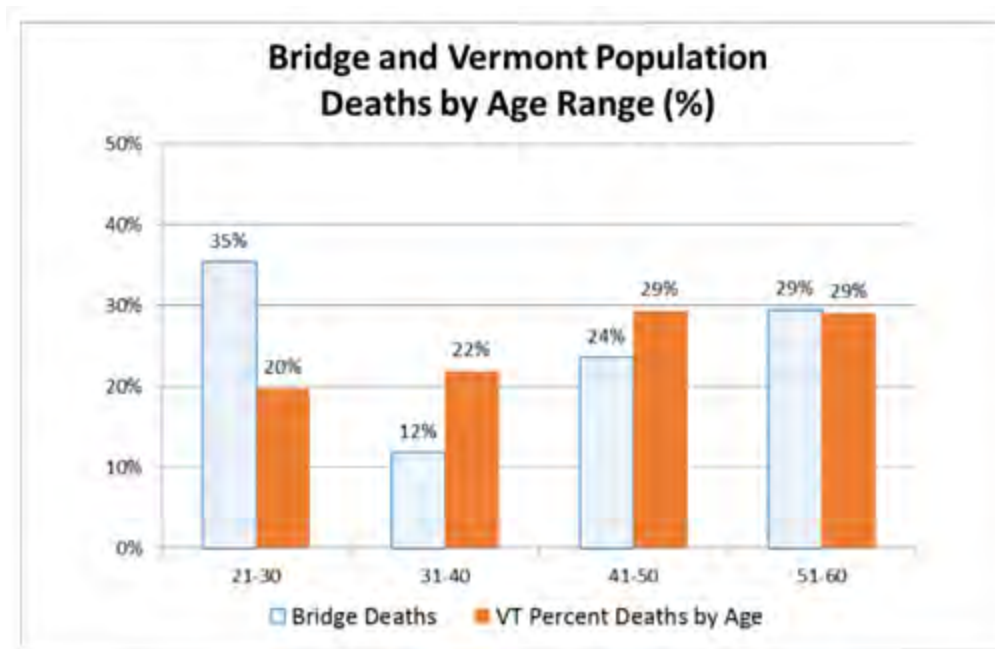

Patterns somewhat similar to this are observed at other bridges. Nationally, bridge suicide ages are on average about 10 years younger than overall average suicide ages.

Rescue and Recovery Operations

When a suicide occurs at Quechee Gorge, the Town of Hartford Fire Department must undertake a costly and risky operation to recover the bodies. Over the years, different approaches have been taken in effort to reduce the risk of death or injury to town public safety staff. Currently the Town uses a special crane mounted on a smaller truck to lift out the body (see photo below, right).



These recovery events, which have occurred two times per year in the past two years, result in the following impacts:

- Diversion of staff and/or cost of staff overtime to conduct the recovery operation, which can take many hours.
- Closure of sidewalk and US 4 traffic, disrupting visitors (most often during the peak season) and creating traffic congestion.
- Risks to town personnel due to the highly hazardous site conditions
- Costs to town for staff time for reporting, investigations, and maintaining proper paperwork.

Means Restriction on Bridges

Many bridges across the world have become the location of one or more suicides. Suicide by jumping from heights poses complex questions in designing a response. Countermeasures must be sufficiently effective to not pose a risk of suggestion, or an apparent challenge. The range of countermeasures is very wide, from providing signage denoting resources to active patrols on facilities in urban populations' centers.

Proposals for means restriction on those bridges often lead to speculation that, if suicides are prevented on a bridge, individuals in crisis will go to another bridge or find another way to kill themselves- a concept known as displacement. Research has demonstrated that "displacement" is rare to nonexistent. The motivation of people who are contemplating suicide is important to understand. Suicidal individuals are most often in a period of deep crisis and pain, and are seeking to end a period anguish. Suicide appears to be an available option. Putting in barriers that can delay or deter their action give these people more time to get through their period of deep pain safely. Bridge mitigation falls within the best practices for suicide prevention, and is the most effective strategy for ensuring a person passes through the crisis period safely. By removing

easy access to means of lethal action, time becomes available for the period of deep crisis to pass.

“Many suicidal crises are self-limiting. Such crises are often caused by an immediate stressor, such as the breakup of a romantic relationship, the loss of a job, or a run-in with police. As the acute phase of the crisis passes, so does the urge to attempt suicide. The temporary nature and fleeting sway of many suicidal crises is evident in the fact that more than 90% of people who survive a suicide attempt, including attempts that were expected to be lethal (such as shooting oneself in the head or jumping in front of a train), do not go on to die by suicide.”

The number of suicides at the Quechee Gorge Bridge is within the range of other bridges in the New England region that have incorporated means restriction, including bridges in Ithaca, NY, Manchester NH and Augusta, ME.

Types of Means Restriction for Bridges

Means restriction has been employed on bridges around the world, and there are many options, falling into two general categories: Barriers and Nets. Increasingly, bridge rehabilitations or replacement projects on suicide-prone bridges are incorporating means restriction. Two ongoing major bridge projects that are incorporating means restriction include the Golden Gate Bridge and the new Tappan Zee Bridge.

Suicide Prevention Barriers

Barriers are by far the most common means restriction used on bridges, and there are a number of options for design and materials. Generally, barriers are between 8 and 10 feet in height. They are designed to be difficult to climb, though are not necessarily impossible to climb, as a fit and determined individual may be able to scale a suicide prevention barrier. The following are the most commonly used types of barriers.

² Guns and Suicide in the United States. Matthew Miller, MD, ScD and David Hemenway PhD. New England Journal of Medicine, 2008; 359:989-991

Chain Link

This is the most widely used means restriction due to low cost, light weight, relatively low wind shear, and ease of installation. However, it has a significant visual impact from both the driver and pedestrian perspective.

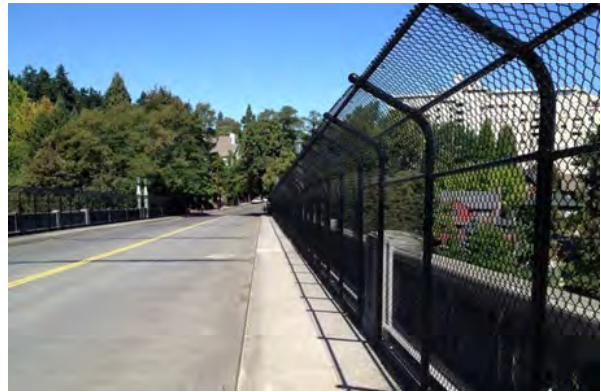

Plexiglass

This is often used as a combination noise barrier/ fence, when visibility is an important consideration. However, it has significant disadvantages including high cost, high wind shear impact, vulnerability to vandalism (painting or scratching), and high maintenance requirements (cleaning).



Steel Mesh

This type of barrier is relatively cost effective and easy to maintain. It can be almost completely transparent for drivers, but has a significant visual impact for pedestrians. The gaps in the mesh are small so that it cannot be climbed; but that will not allow pedestrians to have an unobstructed view, nor take a clear photograph.



Steel Balusters

These are very commonly used, and are composed of vertical steel balusters, typically one inch in diameter and spaced 6 to 8 inches apart. The tops are typically curved inward to make climbing more difficult. The spacing allows a clear view for pedestrians if they stand right at the railing and opportunity to photograph the scenery through the balusters. They add weight and stress to the bridge, and can be more costly to install than lighter weight barriers.



In consideration of the characteristics of Quechee Gorge site conditions, the chain link barrier is not appropriate due to the high visual impact, and plexiglass barrier is not appropriate due to the high maintenance requirements and potential for scratching or vandalism.

Suicide Prevention Nets

Suicide prevention nets have been used on buildings, and increasingly on bridges as an alternative to barriers due to their lower visual impact. The nets are mounted 15 to 20 feet below the bridge rail, and extend out the same distance. They are constructed of stainless steel wire with 8 inch openings. This size opening makes the nets relatively transparent and less likely to trap debris or snow. Nets work by deterring jumps, as the distance down to the nets is sufficient that a potential jumper could be injured, and unable to climb out of the net. Experience has shown that jumps into a suicide prevention net are very rare, and that suicidal individuals are deterred from jumping because it is clear that the jump will not be lethal.

The first use of a suicide net on a bridge was at the Muenster Terrace bridge in Bern, Switzerland, which had been the site of between two to three suicides per year for decades through the late 1990s. The Bern region overall had a very high portion of suicides from jumping, with several bridges being the sites of suicides³. Nets were installed on the Muenster Terrace bridge because it spanned a park, and suicides caused significant trauma and risk to the public. An incident of a jumper landing near a young child prompted the City to install nets in 1998. Since that time, there have been no jumps from the bridge. There had been six suicides at other Bern area bridges in the four years before the nets were installed, and three suicides at these other bridges in the four years after the nets, so there is no evidence of “displacement” to other bridges. The City of Bern has since installed barriers on the two other bridges in the region that had frequent suicides. The overall suicide rate has dropped dramatically, with jumping suicides in Bern now near zero⁴.

Figure 10: Suicide prevention nets on Muenster Terrace Bridge in Bern, Switzerland; net material



Above: Sample of net material; Left, Muenster Terrace Bridge nets, Bern, Switzerland

³ *Securing a suicide hot spot: Effects of a safety net at the Bern Muenster Terrace*, Reisch, Thomas MD and Michel, Konrad, MD. *Suicide and Life-Threatening Behavior* 35(4) August 2005.

⁴ *Golden Gate follows Bern's lead with suicide nets*, by Thomas Stephens, *Swissinfo.ch*, August 14, 2014.

Cornell/Ithaca Bridge Means Restriction Nets

The campus of Cornell University in Ithaca, NY is separated from the City of Ithaca by two deep and scenic gorges on either side of the campus. There are a total of 6 bridges that span the gorges, some owned by the City and others owned by the University. Some serve vehicular and pedestrian traffic and others are pedestrian only. There had been on average 1.5 suicides per year from these bridges, with a spike in 2010 when 3 suicides occurred within a few weeks. This resulted in consideration of means restriction on the gorge bridges, resulting in short term installation of temporary means restriction of a wire mesh fence, and study of other options.



After a study period, suicide prevention nets were installed on six bridges in 2012. The bridges all have different designs and characteristics, and each net installation design is also unique. The total cost of the net installation project was \$7.2 million for six bridges. Concerns about the nets included that there is still a visual impact (though greatly reduced from the mesh fence barrier), and the nets required changes and increased costs for maintenance and inspections practices as well as gorge rescue or recovery operations. The nets are equipped with infra-red detectors to alert public safety staff if anyone falls into the nets. These sometimes trigger false alarms due to birds or other items. The Ithaca Fire Department was provided a small net structure in order to adapt their rescue protocols, and have found them less difficult than feared.

The bridge inspections now require contracting with a private team of climbing bridge inspectors, which costs \$40,000 every other year for inspecting 6 bridges. The nets also are inspected annually at a cost of \$30,000 per year. The nets can be repaired by crimping new wire segments and have an expected service life of 25 years. In the four years since the nets were installed, there has been one suicide where a person jumped into the net, and then climbed out to continue the fall into the gorge.

Conversations with officials at Cornell University and the City of Ithaca indicate an overall positive experience with the nets. They have been very effective at reducing bridge suicides, have low visual impact, and have not presented an undue or unacceptable burden on public safety or maintenance operations.

Research on Means Restriction

There is an extensive body of research that has documented that means restriction will reduce suicides. This research includes epidemiological studies of suicide rates before and after means restriction on suicide bridges, and interviews with suicide attempt survivors. Some studies were not able to make findings that were statistically significant due to small sample sizes, however. Attached to this report is a list of resources that provide more background and detailed research. The following summarize representative research studies.

The Duke Ellington Bridge, Washington DC

This bridge that crosses Rock Creek in NW Washington DC had been the site of 24 suicides between 1979 and 1985. When a suicide barrier was proposed in 1985 after a cluster of three suicides in 10 days, opponents believed that the barriers would not reduce suicides, and that people would merely migrate to the nearby Taft Bridge and jump there. Research was conducted following the installation of barriers⁵, and found that there was no statistical increase in suicides at the Taft Bridge following that barrier installation, and the regional suicide rate declined.

Figure 11: Location of Duke Ellington and Taft Bridges, Washington DC (source: google maps)

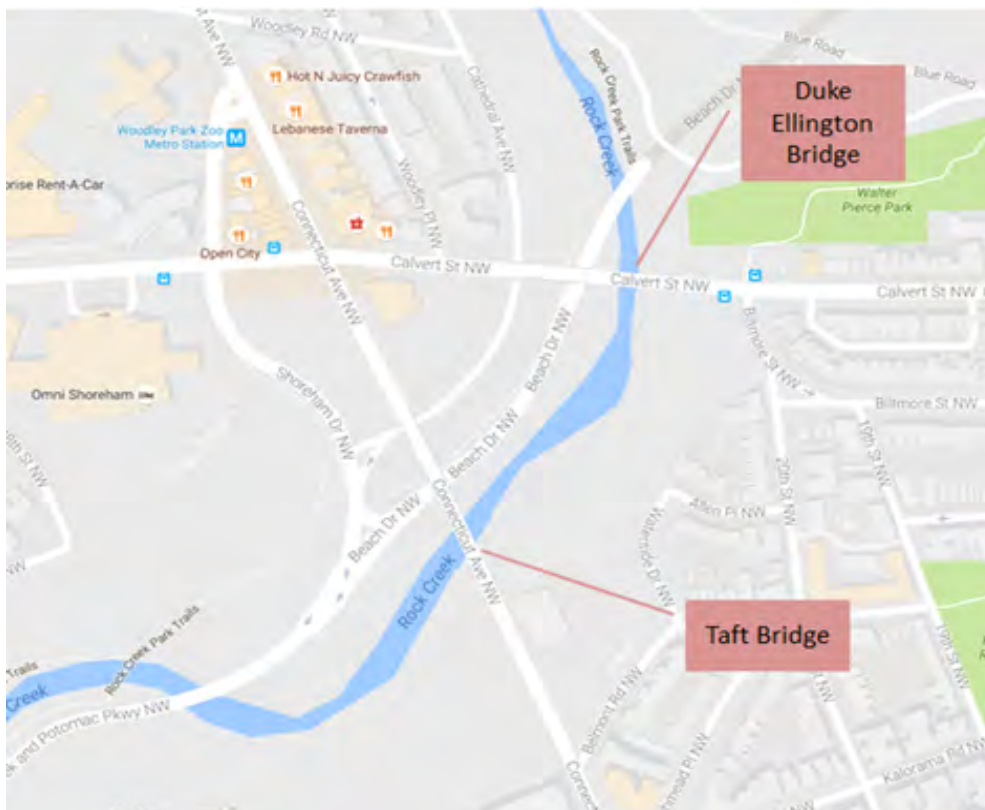

⁵ *Community suicide prevention: The effectiveness of bridge barriers. Suicide and Life-Threatening Behavior.* O'Carroll PW, Silverman MM. 1994;24(1):89-99.

Figure 12: Annual suicide rate on Duke Ellington and Taft Bridges, and regionally*

Comparative Suicide Rate: Ellington and Taft Bridges

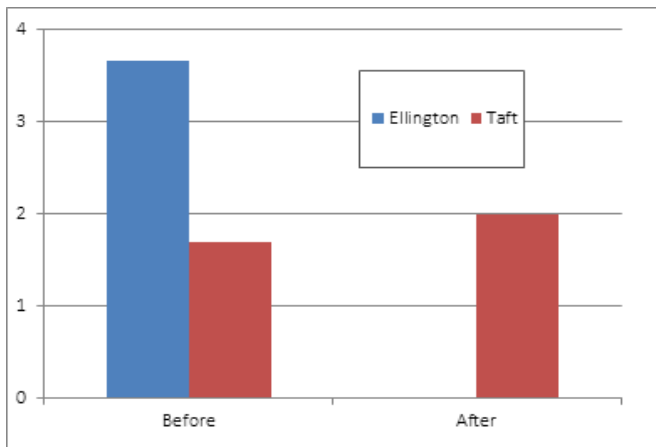

Regional Suicide Rate: Before and after means restriction on Ellington Bridge

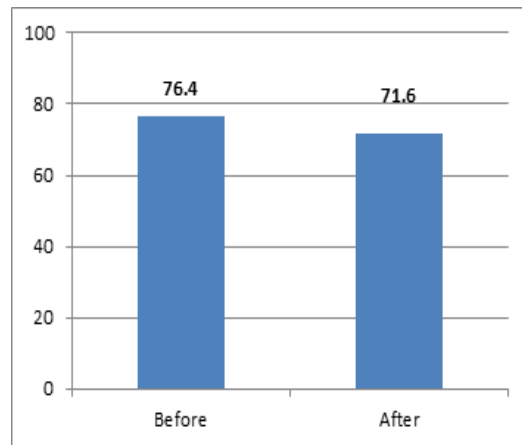

*Before period: 1979 to 1985; After period: 1986 to 1994

The Memorial Bridge, Augusta, Maine

This bridge spans the Kennebec River in an urban setting in Augusta, Maine. There were 14 suicides between 1960 and 1983⁶, when a suicide barrier was installed. In 2005, renovations of the bridge began, and a

decision needed to be made about whether or not to replace the suicide barrier. This prompted research studies to determine if the barrier was effective in reducing overall suicides, or if rather they were shifted to other sites. The results showed that the average number of jumping deaths from



other bridges remained the same before and after the barrier, and that there was no shift of jumping to other bridges. During the period after the barrier was installed, the suicide rate of the Augusta region declined by 9%, and that of the entire state of Maine went down by 3%.

⁶ Preventing suicide by jumping: the effect of a bridge safety fence, Injury Prevention 2007;13:57-59.

Interviews with survivors and attempters

A landmark study⁷ tracked suicide attempters (people who were pulled from Golden Gate bridge, at risk of jumping) showed that only 6% of these people went on to kill themselves.

A New Yorker article⁸ interviewed survivors of bridge jumps, and found similarly that the persons attempting suicide by jumping did not go on to attempts by other means.

“ . . . survivor Ken Baldwin told The New Yorker magazine in 2003 of his attempt to kill himself by jumping off the Golden Gate Bridge, the regret was immediate: "I instantly realized that everything in my life that I'd thought was unfixable was totally fixable — except for having just jumped."

“So I jumped.” But after he [Kevin Hines] crossed the chord, he recalls, “My first thought was What the hell did I just do? I don't want to die.”

Should means restriction be considered for the Quechee Gorge Bridge?

The review of site conditions at Quechee Gorge, the record of suicides, and potential that the bridge may attract people in crisis indicates that consideration of means restriction is appropriate for the Quechee Gorge Bridge.

Means Restriction is effective in reducing suicides. The overwhelming body of research, including epidemiological studies following means restriction installation on bridges, as well as research tracking suicide attempt survivors, suggests that means restriction will reduce suicides. While jumping suicides are a relatively small percentage among all Vermont suicides, they may be among the most readily preventable, and worthy of investing in prevention, considering the young ages of many who have jumped from the bridge.

It has an iconic status that may draw suicidal individuals to the bridge. Of the 9 suicides involving jumping from heights in the state of Vermont between 2008 and 2016, all but two occurred at Quechee Gorge. It is a very well known, iconic bridge that has been shown to attract people in crisis that are considering suicide. The low barrier and lethality of jumps or falls puts an irreversible decision to end their life within reach. The Hartford Police regularly intervene with distraught people on the bridge who appear to be considering suicide. There is no other place in Vermont that is so associated with suicide and so readily accessible, resulting in its attracting individuals in crisis.

⁷ Where are they now? A follow-up study of suicide attempters from the Golden Gate Bridge. Richard H. Seiden, PhD, MPH, Suicide and Life Threatening Behavior, VOL. 8(4), Winter, 1978.

⁸ <http://www.newyorker.com/magazine/2003/10/13/jumpers>

Suicides at the bridge impact on the community and state park. Suicides are terrible tragedies that profoundly and permanently affect family and friends of the individual. Suicides at Quechee Gorge also impact the community, tourists, and the economy. Because they are more frequent in the spring and summer, and some occur during daylight, there can be witnesses who will experience trauma and distress for years from what they have seen. The depth of the gorge makes the recovery operations very challenging and puts the local emergency responders at risk of injury or even death. Recoveries take hours, impose a financial burden on the Town, disrupt traffic, and greatly impact the experience of visitors. On a day of a suicide, a scenic place that should bring joy and inspiration instead is a somber place that brings sadness, and reinforces the reputation of Quechee Gorge as a place for suicides.

Alternatives

The following are options for physical and informational interventions to reduce suicides at the Quechee Gorge Bridge.

1) Do Nothing

This option is being presented as a baseline to compare other alternatives against, and assumes maintenance of the existing conditions. The installation of call boxes and signage, planned for December 2016, are included in this scenario. In addition, lighting of the bridge and parking areas which are currently very poorly lit, is recommended. Lighting of the bridge and parking areas would increase the likelihood that a passer-by would see a person considering suicide on the bridge, and be able to alert the Town police, increasing the chances of a successful intervention.

2) Interventions without means restriction

This alternative includes additional measures such as signage that provides information on where to get help and encouragement for people in crisis to seek help; and surveillance methods such as volunteer watch groups that patrol areas known to have suicide clusters. While it is possible that these help prevent suicides to some extent, the literature review demonstrates that they have not been shown to have a statistically meaningful effect in the prevention of suicide. There are also concerns that this type of information, without a physical means restriction, could reinforce the bridge's reputation as a suicide site, and incite suicidal thoughts.

The Golden Gate Bridge Authority, which has more than 30 deaths per year and many more attempts, conducts constant surveillance to alert emergency responders to potential suicides. This type of approach is unrealistic for the Town of Hartford as it would have a huge cost burden on local law enforcement to provide 24/7 monitoring of the bridge. In addition, the Town has expressed opposition to any approach that involves video surveillance in order to protect privacy.

3) Means Restriction via Barrier (balusters)

This option includes installing a steel baluster barrier at the edge of the sidewalks. Upon consultation with VTrans and discussion of several options for how to configure the barrier, the cross section shown in Figure 13 was developed. The key features of the cross section include:

- US Route 4 cross section modified: 11 ft travel lanes/3 ft shoulders (this width meets the requirements of the Vermont State Standards, HSDEI 11 - 004 and HSDEI 15 - 103)
- Sidewalk widened to 5 ft to meet Public Right-of-way Accessibility Guidelines (PROWAG)

- Vehicle barrier replaced and installed on the curb adjacent to the road shoulder
- New pedestrian railing/suicide prevention barrier installed on outside of bridge
- No modification of bridge beams or relocation of water line required

Figure 13: Means Restriction Barrier Cross Section

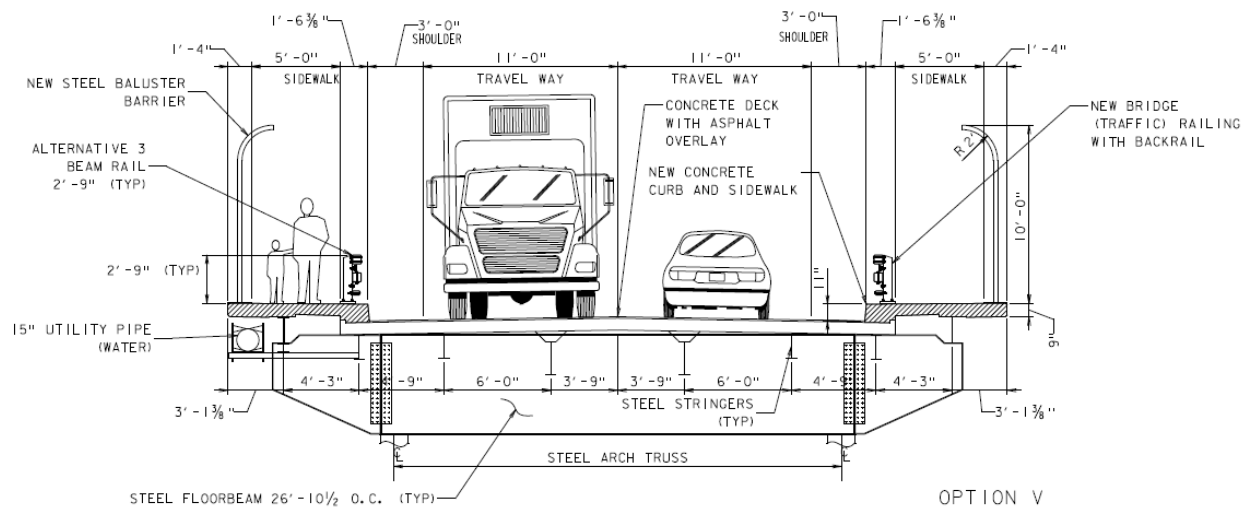

Impacts and Issues

The following were identified as issues to be resolved, and impacts from this alternative to be considered.

- High visual impact, especially to vehicles (see later section discussion visual impacts of the alternatives)
- High cost (in part due to the requirement to upgrade the sidewalks to comply with ADA-see later section on project costs)
- The barrier will require routine cleaning and painting, and will also make routine bridge maintenance, including annual washing, more complicated as the barrier will reduce access to the underside of the bridge. The installation of a catwalk under the bridge could provide useful access for bridge maintenance.
- Town rescue operations and access to gorge will be impeded by the barrier. Possible solutions to address these impact are to make some of the barrier panels removable or to add a permanent catwalk underneath the bridge. While it is expected that suicides will be rare after the installation of the barrier, access may still be needed on occasion for accidents or injuries of park visitors in the gorge.
- Bridge safety inspections will be more challenging with the barrier. Inspections are currently conducted by parking a “snooper” truck adjacent to the bridge rail,

allowing access under the bridge. This could be addressed by the construction of a bridge catwalk under the deck as well, or retaining professional bridge inspectors that are trained in climbing for bi-annual inspections.

- Currently, VTrans uses the sidewalk for snow storage, and periodically removes snow from the bridge. Because the new sidewalk will be separated from the travel lanes, the Town of Hartford will be asked to assume responsibility to maintain the sidewalk, as state plows will no longer have access to the sidewalks.
- It is recommended that the fence height along cliffs extending from the bridge should be increased to 10 feet for a distance of approximately 150 feet to deter jumping from the cliffs as an alternate means of suicide. This higher fencing has been included in the cost estimate..

4) Means Restriction via Net

This option installs suicide prevention nets, with the design similar to what was constructed on two similar bridges in Ithaca, NY. The proposed cross section has nets that are mounted 15 feet below the existing bridge rail, and extend outward 15 feet. Because this alternative does not include any construction on the bridge deck that involve the bridge rails, it will not require that the sidewalks are upgraded to PROWAG. This alternative includes lighting below the bridge deck to illuminate the nets, as it is important for a potential jumper to see the nets for them to be an effective deterrent to jumping. There are steel supports for the net, and cables to maintain the tension.

Figure 14: Suicide Prevention Net Cross Section

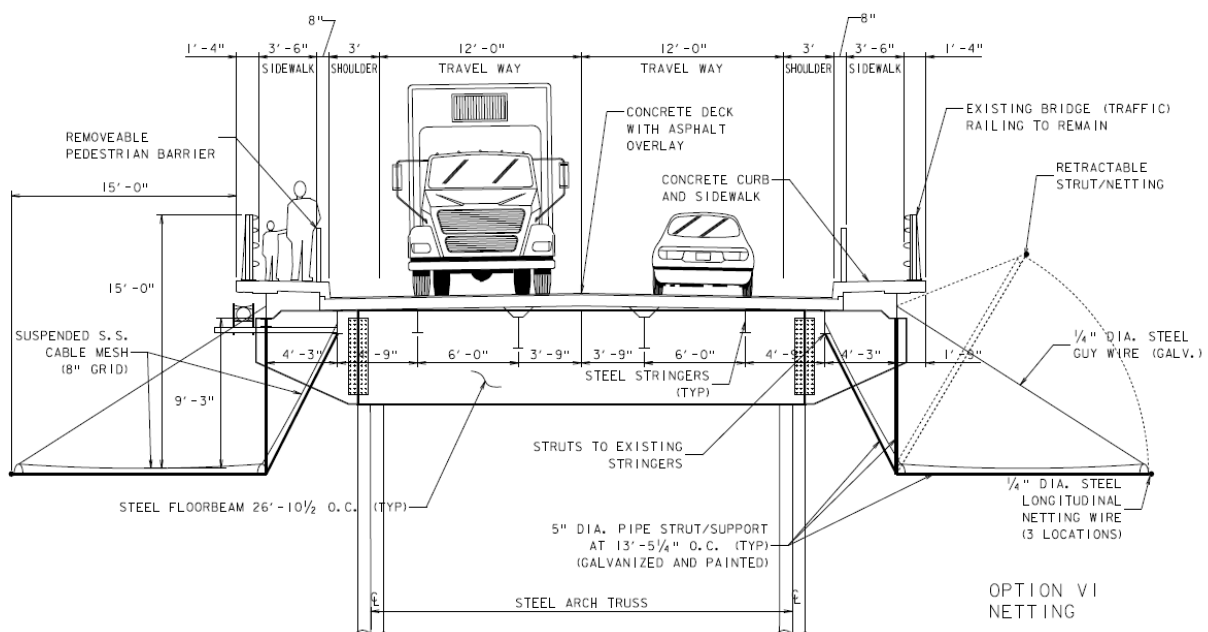

Impacts and Issues

- The nets are expected to have a high cost, as they are a specialty product, and currently not manufactured in the USA. They will need to be inspected annually, and repairs made to any broken wire segments by crimping. (Experience over the last 4 years in Ithaca has been that the nets are very durable, few repairs have been required, and that maintenance concerns regarding litter, debris, and snow/ice build up have not been an issue.)
- The nets will have a much lower visual impact than a barrier (see later section on visual impacts).
- The presence of the nets will require changes to VTrans routine bridge washing, as they will inhibit access to the underside of the bridge. The installation of a catwalk under the bridge could provide useful access for bridge maintenance.
- Bridge safety inspections will be more challenging with the nets. Inspections are currently conducted by parking a “snooper” truck adjacent to the bridge rail, allowing access under the bridge. This could be addressed by the construction of a bridge catwalk under the deck as well, or retaining professional bridge inspectors that are trained in climbing for bi-annual inspections.
- The Town of Hartford recovery operations will need to change from the existing practice, which requires dropping equipment down from the edge of the bridge. The City of Ithaca was required to develop new rescue/recovery protocols as well, and has offered to be a resource to the Town of Hartford if the net option is to be explored further. While it is expected that suicides will be rare after the installation of the barrier, access will still be needed on occasion for accidents or injuries of park visitors in the gorge. If a catwalk is constructed under the bridge, this structure could be used by the Town in the event of any recovery operations are required.
- The Town of Hartford will need to monitor the nets, which can be accomplished via getting alerts from the infra-red detectors, and visual inspections during routine patrols.
- It is recommended that the fence height along cliffs extending from the bridge should be increased to 10 feet for a distance of approximately 150 feet to deter jumping from the cliffs as an alternate means of suicide. This higher fencing has been included in the cost estimate.

5) Temporary Means Restriction with Wire Mesh Fence

Because of the strong public support for taking action to prevent suicides, an option that could be conducted in the short term is proposed for consideration that includes the installation of a wire mesh fence along the bridge rails.

Figure 15: Example of temporary wire mesh barrier from Ithaca, NY



It is anticipated that the wire mesh fence would be installed outside of the existing vehicle rail, with posts interspersed with the existing vehicle rail posts. The wire mesh will need to be of very lightweight gauge if installed in this manner, and should be considered a temporary measure, as the material will not be highly durable.

Impacts and Issues

- Will require changes to maintenance, safety inspections, and rescue operations, as noted above. Because the mesh will be lightweight, it may be more easily removed temporarily to conduct maintenance or bridge inspections.
- Will likely need frequent inspections and potentially repairs due to relatively low durability of fence material.
- Moderate visual impact (see next section for detailed visual impact analysis). Holes can be cut into wire for viewing and photography
- Low installation cost but potentially higher maintenance cost
- Should be considered a very short term (2 years) solution, for the duration of the design and permitting of a more permanent means restriction option.

Potential Project Timeline

The potential timelines for implementation of these alternatives is highly dependent on securing project funding, developing a project design that is acceptable to all parties and affordable, and proceeding with required federal reviews for historic resources. Typically, a project of this magnitude would take up to five years to go through preliminary engineering, permitting, and bidding. However, as these alternatives do not affect the river environment, and have received early coordination for historic and natural resource review, this timeline could be significantly reduced. The temporary wire mesh fence could be implemented rapidly (within one year) if state funds are used.

Potential Impacts of Means Restriction Alternatives

The scope of this study does not allow for a detailed impact assessment, but identifies potential impacts in this sensitive location so that they can be considered early in the assessment of alternatives. The primary concern of the community is the visual impact to the bridge visitors and experience, as well as the impact when viewing the bridge from the trails. The bridge's status as individually listed in the National Register of Historic Places indicates the importance of the historic resource considerations. In addition, there are limited potential impacts to environmental resources.

Visual Impacts

Visual impacts are among the greatest concern of the public due to the huge number of visitors and the significant economic activity from the park, gorge and bridge. Two types of impacts are discussed: the viewshed impact (i.e. what areas will be blocked from view for each alternative), and how the views will change for each alternative from the pedestrian, vehicle and trail user perspectives.

Viewshed Impacts

The barrier, due to its height, will prevent viewers from being able to lean over the rail and look straight down into the gorge. However, the gaps in the barrier will allow for viewers to take photographs straight down into the gorge. The nets will allow visitors to continue to lean over the railing and look straight down, but the bottom of the gorge will be screened by the netting material. Figure 16 shows the relative viewshed impacts of barriers vs. nets. The impact for the barriers is the same for both the temporary and permanent barrier. The barrier essentially cuts off the gorge bottom from view, and the nets will allow the view but it will be screened by the netting material.

Figure 16: Viewshed Impacts from Barrier and Nets

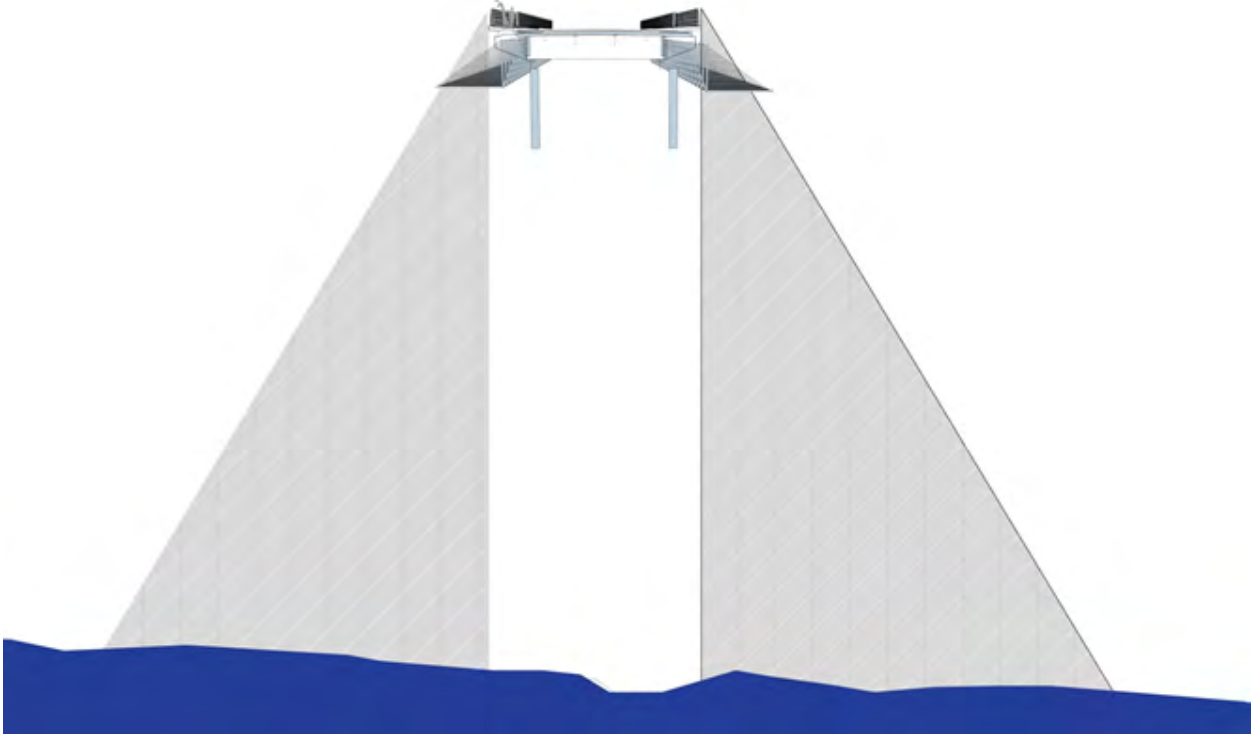
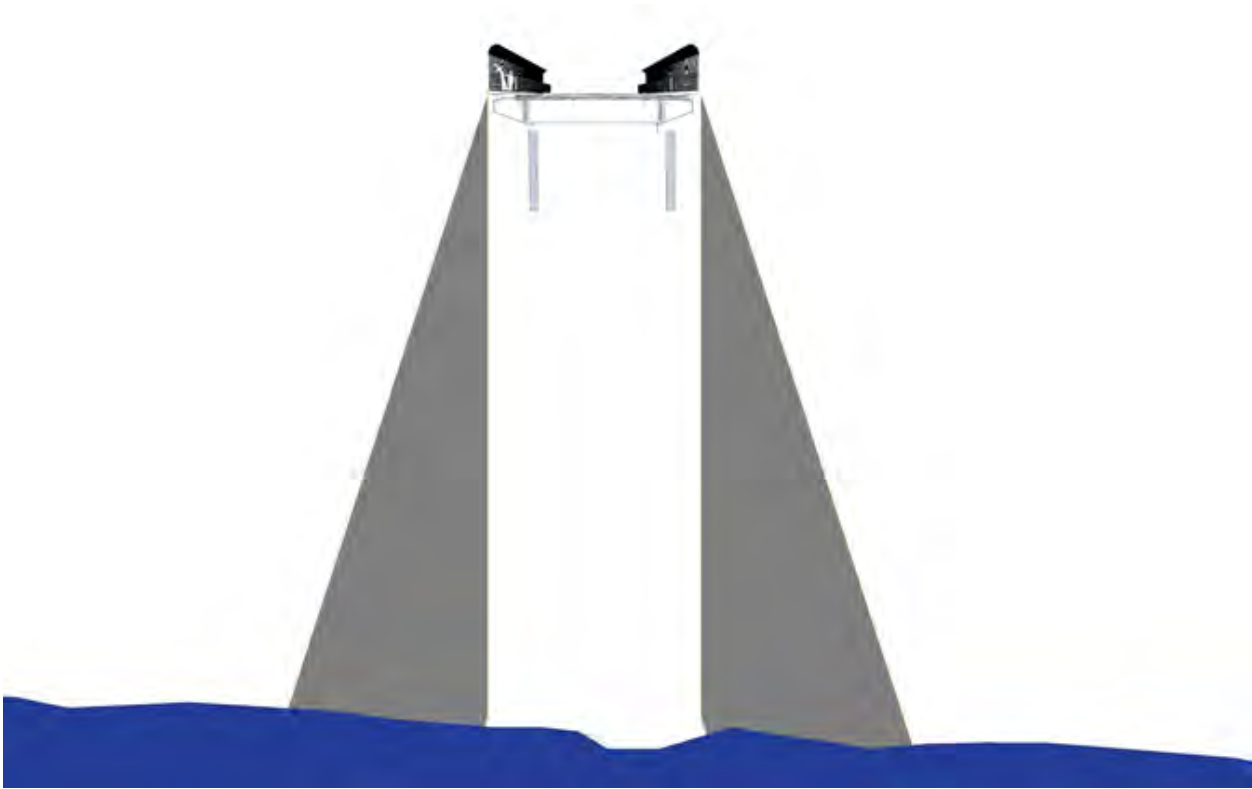

The following photos and photo-simulations illustrate the potential visual impact of the barrier and net alternatives. Views are provided from a variety of perspectives: the sidewalk, the railing, and a driver perspective.

The photos below show views across the bridge from the sidewalk. Both the barrier and wire mesh affect the view; the nets would not be visible from this perspective.

Existing Conditions:



Barrier Alternative:



Net Alternative: (not visible from this view)



Temporary Wire Mesh Alternative:



The photos on the following page show a view from the bridge railing down of the gorge's landscape. The barrier will obstruct the view, though it will be possible for a visitor to peer down between the railings to see the gorge or take a photograph. The nets would not be visible at the angle shown, though a later simulation shows how the net will affect the view down into the gorge. Many visitors enjoy taking selfies of their group, which which will be obstructed by the barrier.

Existing Conditions: View from railing of gorge landscape



Barrier Alternative: View through balusters of gorge landscape



The height of the existing bridge rails allow visitors to peer straight down into the gorge. The barrier option will not allow visitors to look straight down into the gorge between the balusters due to their close spacing (6 to 8 inches). Visitors can put their camera through the balusters and take a photo. The nets will be visible, but their relatively thin gauge wire and large spacing (8 inch) makes the net somewhat transparent.

Existing Conditions: Looking into gorge

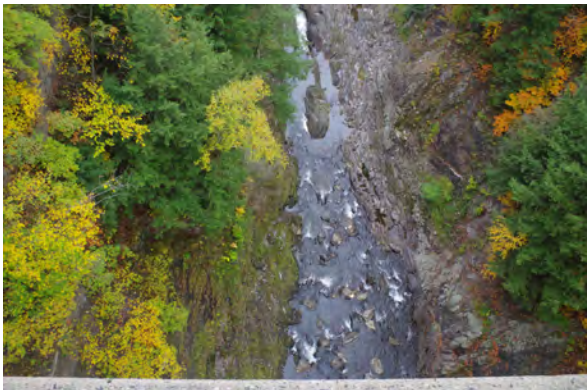

Looking into gorge through net



From a driver perspective, the gorge is not highly visible, but the existing railings allow some view of the landscape. The baluster barrier (below, right) result in a feeling of enclosure while approaching the bridge due to its relatively tall height when compared to the width of the bridge. Most bridges with steel balusters are much wider than the Quechee Gorge Bridge. The landscape would be somewhat visible through the railings while the car is in motion, but they would affect photography and visibility at very low speeds. The nets would not be visible from a car. The wire mesh would be visible, but its narrow gauge would make it more transparent than the steel balusters.

Existing Conditions: Passenger Car View



Barrier Alternative:



Net Alternative: (not visible from car)



Wire Mesh Alternative:



The view of the bridge from the Quechee Gorge State Park trails would be affected, depending on how close the viewer is to the bridge. From a short distance away, all of the options have a muted effect. The selection of color for the barrier or net supports will also affect the visibility.

Existing Conditions



Barrier Alternative



Net Alternative



Wire Mesh Alternative



Visual Impact Discussion

The vertical baluster barrier and temporary barrier will have a significant impact on the views from the gorge due to its height relative to the width of the bridge. While driving through at the posted speed limit, the barriers will be somewhat transparent. However, speeds are often very slow during the peak visitor season, making the barrier more visible to drivers. The nets will have no impact to driver perspective views, nor to distance views from the sidewalk. The nets are the only option that will still allow viewers to look straight down and see the gorge bottom, though the view will be screened by the net.

Cultural Resources

An assessment of the bridge's historic qualities is provided in the appendix. In summary, the bridge is the largest steel arch bridge in Vermont, and is individually listed on the National Register of Historic Places. The bridge structure is highly significant, but the bridge rails do not contribute to the historic significance, so changes to the railings would not alter the bridge's historic character.

Because the alternatives under consideration affect only the bridge and immediate right of way, there is no impact to archaeological resources expected.

Environmental Resources

The environmental resources in the area include the Ottauquechee River, resident wildlife, and a deer wintering area south of the bridge. Because the project scope is primarily limited to the bridge, no impacts are expected to these resources.

There are seven rare, threatened or endangered species in the project area, including plants, bats and birds. The bridge is within one mile of a known Long-eared bat hibernaculum, so biological surveys and evaluation of potential bat roosting sites under the bridge will be required.

Public Input

The project background, alternatives and visual analysis was presented to the community at a public meeting on Wednesday, November 16, 2016. The meeting notes are attached. Overall, there was support for means restriction at the bridge. There was also a strong preference for the net alternative because it maintained the open feeling of exposure to the gorge that the bridge provides, and will have the least change to the visitor experience. The quotes below summarize some of the sentiment expressed at the meeting:

- “We don’t want to be known as a place for suicides . . .something needs to be done.”
- “When Hartford becomes a community that cares, cost really doesn’t matter. When there is an overdose, we come together to figure out a solution.”
- “Nets look like a ‘win-win’”

Project Costs

The means restriction alternatives will have cost associated with construction, as well as maintenance and operations. The construction funding would likely come partially from the Federal Highway Administration, and from the VTrans. The costs for rescue operations are currently born by the Town of Hartford, and the bridge maintenance costs are borne by VTrans.

Construction Costs

The cost estimates presented below should be considered appropriate for planning and programming purposes, but are based on a very preliminary concept design. They are subject to change as the design is developed. The costs were developed using VTrans pay items and estimated quantities for the barrier and wire mesh option, with special provisions estimated for the suicide prevention barrier costs. For the net alternative, the estimates were derived from the bid prices for the Cornell Gorge Bridges net installation, and adjusted for the size of the Quechee Gorge bridge and for inflation.

Table 1: Cost Summary for Means Restriction Alternatives

Item	Barrier	Net	Wire Mesh
Construction (includes 20% contingency)	\$ 1,335,000	\$ 1,470,000	\$ 240,000
Engineering, permitting and bidding	\$ 375,000	\$ 450,000	\$ 50,000
TOTAL PROJECT	\$ 1,710,000	\$ 1,920,000	\$ 290,000

MAP-21 federal transportation funding legislation expressly includes “safety barriers and nets on bridges” so it is reasonable to assume that federal transportation funding could be used on the construction costs. Federal construction funds typically include a 20% state funded match. However, it should be noted that there is currently not a netting manufacturer in the United States, so unless a waiver is granted, the netting alternative would not be eligible for federal funds based on the *Buy America* construction contract requirements. Detailed cost estimates are included in the appendix.

Maintenance Costs

The bridge inspection, maintenance and operational costs are summarized below for current conditions, as well as the barrier and net alternatives.

VTrans current maintenance costs

VTrans operations at District 4 estimates yearly maintenance costs associated with this bridge are as follows:

Table 2: Annual Maintenance and Inspection costs for VTrans

Item	Cost
Pedestrian Fence: Install and Remove	\$5,000
Sweeping	\$700
Washing	\$2,500
Inspection (includes traffic control and safety requirements) ⁹	\$2,000
Snow removal ¹⁰	\$3,600
TOTAL	\$13,800

Inspections are currently conducted every two years, but as the bridge ages and its condition deteriorates, annual inspections are likely to be required in the coming years.

⁹ According to District staff- Inspection costs approximately \$4,000 and is conducted every other year.

¹⁰ According to District staff- snow removal occurs periodically each winter, with an average of twice per winter. The cost reflects an average cost of \$1,800 per cleaning, inclusive of flaggers, personnel, and specialized equipment.

Town of Hartford costs for rescue/recovery operations

With every suicide at Quechee Gorge, the following costs are imposed on the Town of Hartford:

- Recovery costs, includes mobilizing specialized recovery equipment, traffic control, adequately staffing operations, resulting in need for overtime pay, and potential injury to rescue workers.
- Police investigation costs, inclusive of police social worker costs. Every death must be investigated by the police, which takes substantial follow up staff time.
- Medical examiner costs.
- Economic costs. These are not readily calculable, but every suicide incident causes great disruption and sadness to visitors and the businesses that serve them.

The costs of the first three items above are estimated to total \$20,000 recovery costs for each suicide event.

Alternative Costs for Maintenance and Operations

The installation of means restriction will affect VTrans practices for maintenance, as well as bridge inspection. The following table shows estimated costs for the maintenance and bridge inspection for each alternative. These should be considered placeholder estimates based on information available at the time of this report preparation. Actual costs could differ significantly depending on design of the bridge and other decisions.

VTrans Costs for Barrier and Net Alternative

Table 3 itemizes the expected ongoing costs to VTrans for the Barrier and Net alternatives, including continuing maintenance of the bridge, inspection costs for the bridge and nets, and snow removal.

Table 3: Projected annual maintenance and operations costs for barrier alternative

Item	Barrier Cost	Net Cost
Pedestrian Fence: Install and Remove (not required for Barrier; continues for Net)	\$0	\$5,000
Sweeping (continues for both alternatives)	\$700	\$700
Washing (assume cost increases from \$2,500 to \$5,000 due to required change in bridge washing practices)	\$5,000	\$5,000
Inspection (assume bi-annual cost of \$40,000 per inspection as placeholder cost for inspection by team of licensed climbers; \$20,000 per year)	\$20,000	\$20,000
Net Inspection and repair (estimated from actual net inspection costs in Ithaca)	0	\$20,000
Snow Removal	0	\$3,600
TOTAL	\$25,700	\$54,300

Costs to Town of Hartford

For both suicide prevention alternatives, the incidence of suicides is expected to decrease so that they are very rare events. For the barrier alternative, the Town would be required to maintain the sidewalks.

Mitigation options for Maintenance, Inspections, and Operations challenges

Both of the suicide prevention alternatives will make maintenance, inspection, and rescue operations more challenging as they each restrict access to the underside of the bridge. The concept of constructing a catwalk under the bridge is proposed for consideration, which would provide access under the bridge to both the Town and VTrans for public safety operations, bridge inspections, and bridge washing. A review of the bridge structure indicates that a catwalk with approximate 6 feet of clearance under the bridge cross beams would not affect the views of the bridge arch from the trails, though more detailed design, as well as an assessment on the historic structure and views would be required.

Cost Benefit Analysis

The US DOT provides guidance on how to determine the value of saving a human life, which is derived empirically based on what our society is willing to spend to prevent fatalities. The guidance provided by US DOT is to consider these numbers when weighing costs and benefits of infrastructure investments intended to improve safety.

On the basis of the best available evidence, this guidance identifies \$9.4 million as the value of a statistical life to be used for Department of Transportation analyses assessing the benefits of preventing fatalities and using a base year of 2013.

The benefit of preventing a fatality is measured by what is conventionally called the Value of a Statistical Life (VSL), defined as the additional cost that individuals would be willing to bear for improvements in safety (that is, reductions in risks) that, in the aggregate, reduce the expected number of fatalities by one. This conventional terminology has often provoked misunderstanding on the part of both the public and decision-makers. What is involved is not the valuation of life as such, but the valuation of reductions in risks. While new terms have been proposed to avoid misunderstanding, we will maintain the common usage of the research literature and OMB Circular A-4 in referring to VSL.¹¹

US DOT also allows cost-benefit determinations to use a range of values for sensitivity analyses. Kniesner et al. (2012) suggest that a reasonable range of values for VSL is between \$5.2 million to \$13.0 million in 2013 dollars. States are permitted to use their own numbers for cost-benefit analysis, which are typically somewhat lower, and average at \$3.3 million. Vermont has not adopted an alternative. Based on research and past experience elsewhere, it can be expected that the investment in means restriction on the Quechee Gorge Bridge would have a positive cost-benefit analysis, even if much lower alternative life valuation numbers are used.

Analysis of Alternatives

Table 4 on the following page summarizes the costs, features and considerations for each alternative.

¹¹ *Guidance on Treatment of the Economic Value of a Statistical Life (VSL) in US Department of Transportation Analyses*, Memorandum to Secretarial Officers and Modal Administrators, from Kathryn Thomson, General Counsel, dated June 17, 2015.

Table 4: Cost Summary of Alternatives

	Construction Cost	Annual Cost to VTrans	Annual Cost to Hartford	Suicide Prevention Effect	Visual Impact	Public Support	Improve pedestrian facilities	Considerations for State (VTrans and FPR)	Considerations for Town of Hartford	Considerations for public and local businesses
No Build/ Do Nothing	\$0	\$11,800 Maintenance \$2,000 inspection	\$20,000 per recovery* unknown costs to local businesses	None	No	No – Action is desired	No	Continued need to coordinate with town on investigations or emergency response; Impact to visitors of Quechee Gorge State Park.	Emergency responders cost and risk; social workers responding for interventions; police investigation of deaths	Witness trauma; disruption of visitors, US 4 traffic and businesses.
Non-Means Restriction (e.g. Signage)	Less than \$0.01 million	\$11,800 Maintenance \$2,000 inspection	\$20,000 per recovery unknown costs to local businesses	Unclear; likely none	No	No – community desires a proven means	No	Continued need to coordinate with town on investigations or emergency response. Impact to visitors of Quechee Gorge State Park.	Emergency responders cost and risk; social workers responding for interventions; police investigation of deaths	Witness trauma; disruption of visitors, US 4 traffic and businesses.
Suicide Prevention Barrier	\$1.7 million	\$5,700 Maintenance \$20,000 inspection	Recovery costs expected to be \$0 Maintenance of sidewalk \$5,000	Yes	Severe	No – due to visual impact	Yes	Additional maintenance and inspection costs assumed due to barrier restricting access under bridge; Barriers will require inspection and painting; Safety of VTrans maintenance and inspection staff also to be considered.	Rescue/recovery methods and equipment will have to be altered. High effectiveness for suicide prevention will reduce recovery and intervention costs.	High visual intrusion will change Quechee Gorge experience.
Suicide Prevention Net	\$1.9 million	\$24,300 Maintenance \$20,000 inspection	Recovery costs expected to be \$0	Yes	Moderate	Yes	No	Additional maintenance and inspection costs assumed due to barrier restricting access under bridge; Net and camera/detector maintenance needed; Safety of VTrans maintenance and inspection staff also to be considered.	Town will monitor infrared cameras and investigate incidents on nets. High effectiveness for suicide prevention will reduce recovery and intervention costs.	Nets will have relatively low impact on visitor experience.
Temporary Wire Mesh Barrier	\$0.3 million	\$11,800 Maintenance \$2,000 inspection	Recovery costs expected to be \$0	Yes	Moderate-Severe	Unknown	No	Mesh would be removable to allow for inspections, washing, etc. Safety of VTrans maintenance and inspection staff also to be considered.	Mesh will be removable to allow access to gorge for incident response.	High visual intrusion will change Quechee Gorge experience. Holes could be cut into fence for viewing.

Conclusions

Based on the research and assessments in this report, the following conclusions can be drawn:

- Means restriction on bridges has been shown to be effective and can be expected to reduce suicides.
- Construction of means restriction on the Quechee Gorge Bridge will greatly reduce the impacts and burden that bridge suicides have on the community.
- The Town of Hartford has expressed support for means restriction for these reasons.
- The most feasible options for means restriction are nets or a steel baluster barrier. A temporary option that is also feasible is a lightweight steel mesh fence.
- Suicide prevention nets will have a much lower visual impact than a baluster barrier. For this reason, input from the community has been voiced in preference for nets.
- The construction cost for either option is in the order of magnitude of \$2 million.
- Either option will require changes in how the bridge is maintained and inspected, and how rescue or recovery operations are conducted. The ongoing cost for VTrans for maintenance, operations and inspections will increase with either alternative, but more for the nets.
- The construction of a catwalk under the bridge could have substantial benefits and cost savings for VTrans operations and bridge inspections. It could also be utilized by the Town of Hartford for gorge rescues.
- Lighting of the bridges and parking areas is an early action that can be taken that might increase the opportunity for passersby or police to see someone at risk of suicide and intervene.

Appendix

- 1) Text of relevant portions of 2016 Transportation Bill
- 2) Resource reviews (checklist, historical, archaeological, environmental)
- 3) Public meeting notes and presentation
- 4) TAC meeting notes
- 5) Cost estimates

administrative assistance to the Board and such other assistance as the Board may require to carry out its duties.

(d) Standards. The Agency shall update the statewide property parcel data layer in accordance with the standards of the Vermont Geographic Information System (VGIS), as specified in 10 V.S.A. § 123 (powers and duties of Vermont Center for Geographic Information).

(e) Funding sources. Federal transportation funds shall be used for the development and operation of the Program. In fiscal year 2018 and in succeeding fiscal years, the Agency shall make every effort to ensure that all State matching funds are provided by other State agencies or external partners or both that benefit from the Program.

* * * Quechee Gorge Bridge Safety Issues * * *

Sec. 38. QUECHEE GORGE BRIDGE SAFETY ISSUES

(a) On or before July 1, 2016, or as soon as practicable thereafter if a longer period is required to obtain necessary permits or satisfy federal requirements, the Agency shall complete a project on or proximate to Bridge 61 on US Route 4 in the town of Hartford (Quechee Gorge Bridge) to install a structure providing information and resources, signs, or communication devices, or some combination of these, aimed at preventing suicides at the Quechee Gorge Bridge.

(b) In consultation with the Agency of Commerce and Community Development, the Department of Health, the Department of Mental Health, the

Department of Public Safety, local officials, local emergency personnel, the Hartford Area Chamber of Commerce, mental health practitioners, local business owners, and other interested stakeholders, the Agency of Transportation shall thoroughly review suicide prevention as well as pedestrian, first responder, and other safety measures that could be taken, and the merits of taking such measures, at the Quechee Gorge Bridge. In conducting this review, the Agency shall identify:

(1) short- and long-term suicide prevention as well as pedestrian, first responder, and other safety measures for all users that could be taken at the Quechee Gorge Bridge in addition to the measures taken pursuant to subsection (a) of this section, including:

(A) providing information and resources, including emergency contact information and means of emergency communication; and

(B) physical improvements to the bridge structure and the surrounding area;

(2) estimated costs and benefits and an expected timeline associated with implementing the measures identified in subdivision (1) of this subsection; and

(3) economic, community, and tourism concerns associated with implementing the measures identified in subdivision (1) of this subsection.

(c) On or before January 10, 2017, the Agency shall report the results of the review required under subsection (b) of this section to the House and Senate Committees on Transportation.

* * * Vulnerable Users * * *

Sec. 39. 23 V.S.A. § 1033 is amended to read:

§ 1033. PASSING MOTOR VEHICLES AND VULNERABLE USERS

(a) Passing motor vehicles. Motor vehicles proceeding in the same direction may be overtaken and passed only as follows:

(1) The driver of a motor vehicle overtaking another motor vehicle proceeding in the same direction may pass to its left at a safe distance, and when so doing shall exercise due care, shall not pass to the left of the center of the highway ~~unless the way ahead is clear of approaching traffic~~ except as authorized in section 1035 of this title, and shall not again drive to the right side of the roadway until safely clear of the overtaken vehicle.

(2) Except when overtaking and passing on the right is permitted, the driver of an overtaken motor vehicle shall give way to the right in favor of the overtaking motor vehicle ~~on audible signal~~ and shall not increase the speed of his or her vehicle until completely passed by the overtaking vehicle.

(b) Passing vulnerable users. The operator of a motor vehicle approaching or passing a vulnerable user as defined in subdivision 4(81) of this title shall exercise due care, which includes increasing clearance to a recommended distance of at least four feet, to pass the vulnerable user safely, and shall cross



OFFICE MEMORANDUM

AOT - PDB - ENVIRONMENTAL SECTION

RESOURCE IDENTIFICATION COMPLETION MEMO

TO: Jackie Cassino, Project Manager

FROM: Lee Goldstein, Environmental Specialist, SE Region

DATE: December 12, 2016

Project: Quechee Gorge Bridge-Proposed Suicide Prevention Measures

ENVIRONMENTAL RESOURCES:

- Archaeological Site: Yes No see Archaeological Resource ID Memo, per measures as proposed; any change beyond proposed SOW requires additional review
- Historic/Historic District: Yes No see HP Resource ID Memo for details; Bridge No. 61 is Registered
- 4(f) Property: Yes No Any Adverse Effect to Bridge No. 61 will require a 4(f) Consultation
- Wetlands: Yes No see Natural Resource ID Memo
- Agricultural Land: Yes No n/a
- Fish & Wildlife Habitat: Yes No exists but no impact; however, any change beyond proposed SOW requires additional review
- Wildlife Habitat Connectivity: Yes No exists but no impact; however, any change beyond proposed SOW requires additional review
- Endangered Species: Yes No both threatened and rare; see Natural Resource ID Memo for details regarding this subject
- Invasive Species: Yes No not identified within project 'area of potential effect'
- Stormwater: Yes No n/a
- Landscaping: Yes No n/a
- 6(f) Property: Yes No not identified within project 'area of potential effect'
- Hazardous Waste: Yes No not identified within project 'area of potential effect'
- Contaminated Soils: Yes No not identified within project 'area of potential effect'
- USDA-Forest Service Lands: Yes No not identified within project 'area of potential effect'; however, adjacent 'Conserved Lands' exist
- Scenic Highway/Byway: Yes No U.S. Route 4 is designated 'Crossroads of Vermont Byway'
- Act 250 Permits: Yes No will not impact existing or trigger new per proposed SOW
- FEMA Floodplains: Yes No n/a
- Flood Hazard Area/
River Corridor: Yes No any change beyond proposed SOW would require additional review
- US Coast Guard: Yes No any change beyond proposed SOW would require additional review
- Lakes and Ponds: Yes No n/a
- Environmental Justice: Yes No no impacts as proposed
- 303D List/ Class A Water/
Outstanding Resource Water: Yes No the Ottauquechee River is 'Essential Fish Habitat' and regulated by the ACOE; any change beyond proposed SOW would require additional review and possible permitting
- Source Protection Area: Yes No no impacts as proposed
- Public Water Sources/
Private Wells: Yes No no impacts as proposed
- Other: Yes No n/a per proposed SOW

cc: Project File

Kyle Obenauer

Historic Preservation Specialist

kyle.obenauer@vermont.gov

802.279.7040

www.vtrans.vermont.gov

Vermont Agency of Transportation

Project Delivery Bureau - Environmental Section

One National Life Drive

Montpelier, VT 05633-5001

Historic Preservation Resource Identification Memo

To: Lee Goldstein, Environmental Specialist
Via: Judith Ehrlich, VTrans Historic Preservation Officer
Cc: Brennan Gauthier, VTrans Archaeologist
Karen Spooner, Administrative Assistant
Date: October 18, 2016

Subject: Hartford US 4 – Quechee Gorge Bridge Suicide Prevention Study

I have completed a resource identification for Hartford US 4 – Quechee Gorge Bridge Suicide Prevention Study. One historic resource was identified within a potential project area: the Quechee Gorge Bridge.

Constructed in 1911, the Quechee Gorge Bridge (Bridge No. 61) was designed for the former Woodstock Railroad in 1911, by John W. Storrs. Fabricated by the American Bridge Company, this arched, tri-span parabolic, spandrel-braced steel Pratt truss measures 285 feet long by 41 feet wide and carries US Route 4 approximately, 163 feet above the Ottauquechee River in Hartford (Figure 1).

The Quechee Gorge Bridge is individually listed in the National Register of Historic Places (NRHP) for its significance under Criteria A and C, as a distinct property type that meets the eligibility registration requirements contained within the 1990 *Metal Truss, Masonry, and Concrete Bridges in Vermont* multiple property documentation form.

As the 1990 NRHP nomination form notes:

The bridge (Bridge 61) was built in 1911, to carry the tracks of the Woodstock Railroad over the gorge and replaced an 1875 wooden truss bridge which was less suited for heavyweight, twentieth century locomotives. In 1933, the right of way was taken over for U.S. Route 4, and the bridge was converted for highway use. This procedure chiefly required adding stringers and a concrete deck to the system... At the time John W. Storrs designed this bridge, he was employed as a bridge engineer for the Boston and Maine Railroad. He also worked as an independent consultant for others including the Woodstock and Montpelier and Wells River Railroads. Around 1909, his son Edward, associated with him and by 1915 the firm, known as Storrs and Storrs, was doing a large business in northern New England...The Quechee Gorge bridge appears to be the largest and most sophisticated bridge Storrs designed.

Today, Bridge No. 61 is the largest steel arch truss bridge in Vermont. When the structure was converted to automobile use during the Great Depression, its deck was substantially altered, including the addition of a paved roadway and railings (Figures 2-5). However, these alterations did not substantially diminish the historic integrity of the Quechee Gorge Bridge and today, two contemporary metal rail types line both sidewalks at the inner- and outer edges of this structure. The extant railings and fencing on the Quechee Gorge Bridge are not considered character defining features of this NRHP-listed structure (Figure 6).

At the northeastern corner of Bridge No. 61, is a one-story commercial building that is currently the location of Quechee Gorge Gifts & Sportswear (Figure 7). Constructed in 1946-47, this building was designed by the celebrated modernist architects Edgar Hayes(EH) and Margaret King(MK) Hunter to function as a retail outlet and restaurant

for the Quechee-based Dewey Corporation, a large textile manufacturer located directly northwest of the Quechee Gorge Bridge and Dewey building, near Dewey's Pond (Figures 8-9).

The North Carolina-based NC Modernist notes that:

The Hunters practiced in Hanover NH from 1945-1966, both teaching at Dartmouth and designing several buildings on that campus. They were featured in the 1950, 1953, and 1956 *Architectural Record*. In 1957, they hired Roy Banwell as an associate. Margaret Hunter was featured in the 1958 *Time/Life Picture Cookbook* for being "one of the few successful women architects." In 1966 they relocated to Raleigh primarily because the demand for architecture in VT and NH had faded. There was also difficulty finding contractors who could build modern design correctly. They left the NH practice to Roy Banwell. In Raleigh, Ted worked for Lyles Bissett Carlisle and Wolff and Peg taught at NCSU. After a time, Ted left the firm and the pair opened up shop as EH and MK Hunter AIA.

This modernist retail building has been significantly altered, including additions to its roof, main facade, fenestration, and the addition of a large, rectangular one-story ell at its rear. Although some original design elements are still legible from the building's exterior, VTrans has determined that the former Dewey Corporation building does not retain sufficient historic integrity for individual inclusion in the NRHP.

Finally, both the Quechee Gorge Bridge and former Dewey Corporation building are southeast of the NRHP-listed Quechee Historic Mill District – VTrans has determined that neither the Quechee Gorge Bridge or former Dewey Corporation building appear eligible for inclusion in the NRHP as a contributing resources to this historic district or any other current or potentially significant concentration, linkage, or continuity of sites, buildings, structures, or objects united historically or aesthetically by plan or physical development.

Please, contact me with any questions. Additional background information and documentation can be provided upon request.



Figure 1. Quechee Gorge Bridge (Bridge No. 61), looking south



Figure 2. Construction of Quechee Gorge Bridge in 1911.



Figure 3. Completed bridge in 1911. Note rail deck.

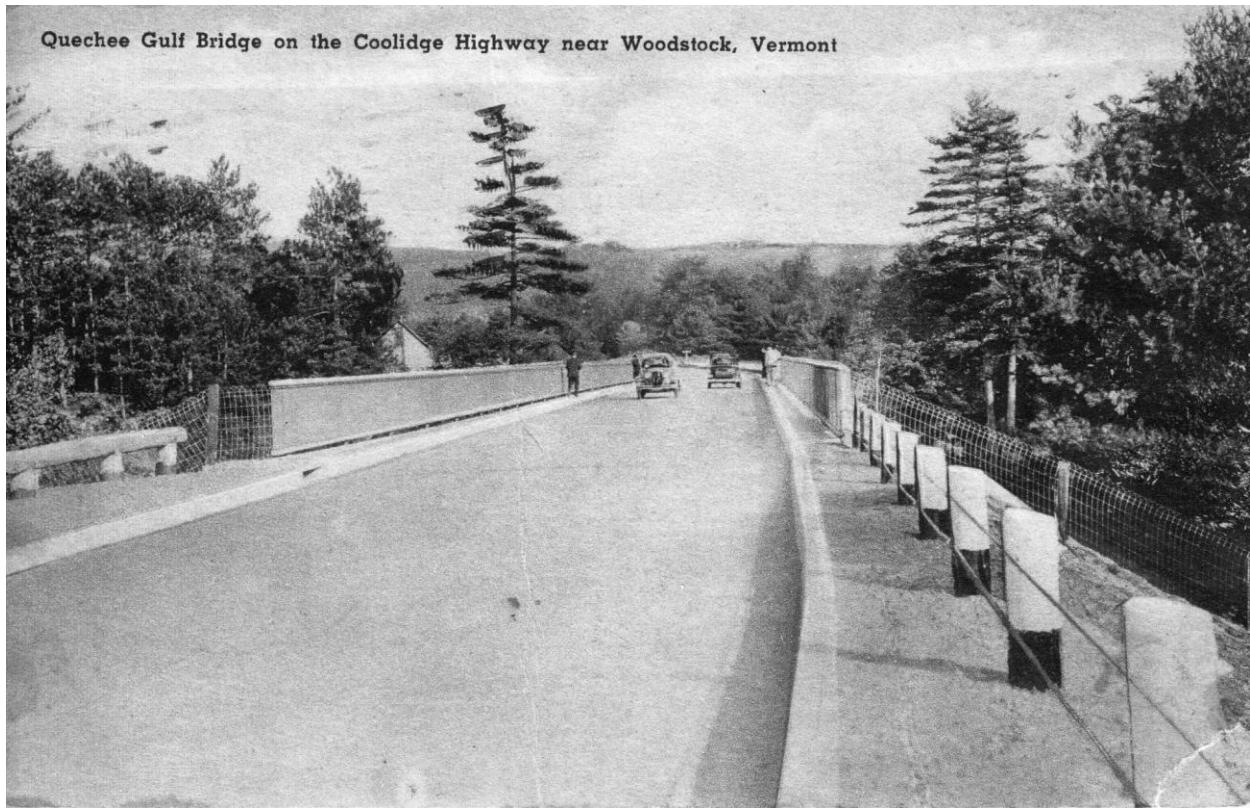

Figure 4. Alterations and new functions on deck of Quechee Gorge Bridge in 1933, looking east on US Route 4.



Figure 5. Quechee Gorge Bridge looking northeast. Image from 1990 NRHP nomination. Note contemporary rails.



Figure 6. Contemporary rails on the Quechee Gorge Bridge, looking west.



Figure 7. Quechee Gorge Gifts at northeastern corner of Bridge No. 61, former location of the Dewey Corporation's retail store and restaurant.



Figure 8. Building shortly after construction, in 1946-47.



Figure 9. Dewey Corporation building on 1950s postcard.

Brennan Gauthier

VTrans Archaeologist
Vermont Agency of Transportation
Project Delivery Bureau
Environmental Section
1 National Life Drive
Montpelier, VT 05633
tel. 802-279-1460
Brennan.Gauthier@Vermont.gov

To: Lee Goldstein, Environmental Specialist
From: Brennan Gauthier, VTrans Archaeologist
Date: 11/15/2016
Subject: Quechee Gorge Suicide Prevention Net Installation

Lee,

I have completed my resource identification for the proposed Quechee Gorge Bridge suicide prevention nets and signage on Bridge #61 that spans the Ottauquechee River in Hartford, Windsor County, VT. The current project plans are in preliminary form, but the eventual installation will likely be confined to the bridge structure with the potential for sign/suicide phone installation within the right of way (ROW) at both approaches. These proposed plans will have limited, if any, physical footprint beyond the existing roadway prism. Although an interesting and important structure in the history of Vermont bridge construction, the project APE, as currently defined, is not considered sensitive for archaeology.

Please feel free to reach out with any questions or concerns that may arise as part of this project. Project plans, photographs and maps will be compiled upon the completion of the final Section 106 letter and are not included here.

Sincerely,



Brennan

**State of Vermont
Program Development Division**

One National Life Drive
Montpelier, VT 05633-5001
vtrans.vermont.gov

[phone] 802-279-2562
[fax] 802-828-2334
[ttd] 800-253-0191

Agency of Transportation

To: Lee Goldstein, VTrans Environmental Specialist
From: James Brady, VTrans Environmental Biologist
Date: October 12, 2016
Subject: Quechee Gorge Bridge Suicide Prevention Project- Natural Resource ID

I have completed my natural resource report for the above referenced project. My evaluation has included wetlands, wildlife habitat, agricultural soils, and rare, threatened and endangered species.

Wetlands/Watercourses

There are no wetlands within the project area.

The Ottauquechee River flows under the project area.

Wildlife Habitat

It is assumed that the Ottauquechee is a corridor for both terrestrial, avian and aquatic fish and wildlife. Due to the height of the bridge, it is not anticipated that work on the bridge will interrupt any movement.

The area directly south of the bridge is a mapped deer wintering area. Tree clearing should be avoided or minimized to the best extent practicable.

Rare, Threatened and Endangered Species

There are seven rare, threatened or endangered species mapped in the project area. These range from plants to bats and birds. Any tree clearing or access that will require the clearing of vegetation will require closer review due to the sensitive nature of the area surrounding the bridge.

This area is also within a one-mile radius of a known norther long-eared bad hibernaculum. This species is federally threatened and any work on the bridge will likely require time-of-year restrictions or exit surveys performed by a certified biologist. All tree clearing and bridge work must be reviewed by a VTrans biologist. There are several areas, mainly at the joints, that appear to be potential bat roosting habitat.

Agricultural Soils:

There are statewide agricultural soils adjacent to the project area. No impacts are anticipated.

Kyle Obenauer
Historic Preservation Specialist

Vermont Agency of Transportation

Project Delivery Bureau - Environmental Section
One National Life Drive
Montpelier, VT 05633-5001

kyle.obenauer@vermont.gov
(802) 279-7040
www.vtrans.vermont.gov

Memorandum: Quechee Gorge Suicide Prevention Study

To: Jackie Cassino, VTrans Planning Coordinator
Cc: Judith Ehrlich, VTrans Historic Preservation Officer

Date: January 4, 2017

Subject: Installation of Catwalk and Comments on Draft Report

Jackie,

In the following paragraphs, I've included a few comments regarding the potential installation of a catwalk(s) on the Quechee Gorge Bridge, as a component of a cantilevered-net suicide prevention system, considered for future implementation on this structure along US Route 4, in Hartford. Additionally, I've also made a few comments regarding potential Section 106 and Section 4(f) review implications, generally, as well as notes that will help to clarify the historic significance and designation of the structure within the *Suicide Prevention Alternatives* (Report) text, distributed as a .pdf on December 27, 2016.

Constructed in 1911, the Quechee Gorge Bridge (Bridge No. 61) was designed for the former Woodstock Railroad by John W. Storrs. Fabricated by the American Bridge Company, this arched, tri-span parabolic, spandrel-braced steel Pratt truss measures 285 feet long by 41 feet wide and carries US Route 4 approximately, 165 feet above the Ottauquechee River in Hartford. Today, this bridge is the largest steel arch truss in Vermont.

The Quechee Gorge Bridge is individually listed in the National Register of Historic Places (NRHP). The NRHP is the official list of the Nation's historic places worthy of preservation. Authorized by the National Historic Preservation Act of 1966, the National Park Service's National Register of Historic Places is part of a national program to coordinate and support public and private efforts to identify, evaluate, and protect America's historic and archaeological resources.

The U.S. Department of the Interior's National Park Service has issued a set of standards and concepts referred to as *The Secretary of the Interior's Standards*, which provide guidance on maintaining, repairing, and replacing historic materials, as well as designing new additions and making alterations to historic resources. Essentially, these standards provide a framework for decision-making about work or changes to a historic property, and are codified in 36 CFR 67.

The *Secretary of the Interior's Standards for Rehabilitation* would be applicable to repairs, alterations, or additions to the Quechee Gorge Bridge, as part of a suicide means restriction project. Of the 10 Rehabilitation Standards, Numbers 9-10 are important to note for the Report:

9. New additions, exterior alterations, or related new construction will not destroy historic materials, features, and spatial relationships that characterize the property. The new work will be differentiated from the old and will be compatible with the historic materials, features, size, scale and proportion, and massing to protect the integrity of the property and its environment;
10. New additions and adjacent or related new construction will be undertaken in such a manner that, if removed in the future, the essential form and integrity of the historic property and its environment would be unimpaired.

Any means restriction alternative considered for suicide prevention at the Quechee Gorge Bridge should be evaluated using *The Secretary's Standards*, including the installation of a catwalk(s) and other apparatus associated with a net system. Measures to minimize and mitigate potential adverse effects associated with installing such a suicide prevention measure might include, but are not limited to: matching paint of newly-installed catwalk/net supports to the existing trusses; designing a catwalk and supports that visually blend into the steel truss structure when viewed by the public; and, the use of materials and proportions that are harmonious with the existing historic steel substructure.

As we have previously discussed, work associated with the installation of suicide means restriction at this historic bridge would most likely be reviewed under Section 106 of the National Historic Preservation Act and Section 4(f) of the Department of Transportation Act, among other state and federal legislation. Under 23 CFR 774.13(a), if a Department of Transportation project results in a No Adverse Section 106 determination of effect, the project may be exempt from Section 4(f) review; however, it is important to note that under Section 106, a No Adverse determination of effect might still require Section 4(f) review, if a selected alternative adversely affects or uses other Section 4(f) property types, such as the adjacent, publicly-owned Quechee State Park. Parts of this park might qualify as a Multiple Use Land Holdings Section 4(f) resource.

Once a means restriction alternative is selected, the severity of visual impact(s) and necessary alterations to the Quechee Gorge Bridge and possibly, the neighboring Quechee State Park, are some of the primary deliberations that will be weighed in our Section 106 and Section 4(f) reviews, if necessary. Although visually less intrusive, a catwalk/net system of means restriction installed on the bridge substructure has more potential to adversely affect the significant, character-defining steel trusses of the Quechee Gorge Bridge, compared to a chain link barricade or other means restrictions measures installed on the bridge superstructure; however, as noted above, other considerations, including visual impacts to additional resources within an area of potential effect, must also be considered.

To re-iterate, using the included *Secretary of the Interior's Standards for Rehabilitation* will be a very useful mechanism throughout project planning to help avoid, minimize, and mitigate adverse effects to the Quechee Gorge Bridge, associated with the potential installation of a catwalk/net system of means restriction, or other alternatives.

Please, let me know if you or anyone else has questions about this bridge and suicide means restriction measures at the Quechee Gorge Bridge. Thanks, again for including the VTTrans Historic Preservation Staff in the development of the *Quechee Gorge Bridge Suicide Prevention Alternatives* report.

Sincerely,

Kyle Obenauer

Notes

- A. What will Appendix 3) Resource Reviews contain for historic resources? Is there anything you are missing or might like to include?
- B. I've made comments within draft Report.

Secretary of the Interior's Standards for Rehabilitation

When repair and replacement of deteriorated features are necessary; when alterations or additions to the property are planned for a new or continued use; and when its depiction at a particular period of time is not appropriate, Rehabilitation may be considered as a treatment.

Standards for Rehabilitation

1. A property will be used as it was historically or be given a new use that requires minimal change to its distinctive materials, features, spaces, and spatial relationships.
2. The historic character of a property will be retained and preserved. The removal of distinctive materials or alteration of features, spaces, and spatial relationships that characterize a property will be avoided.
3. Each property will be recognized as a physical record of its time, place, and use. Changes that create a false sense of historical development, such as adding conjectural features or elements from other historic properties, will not be undertaken.
4. Changes to a property that have acquired historic significance in their own right will be retained and preserved.
5. Distinctive materials, features, finishes, and construction techniques or examples of craftsmanship that characterize a property will be preserved.
6. Deteriorated historic features will be repaired rather than replaced. Where the severity of deterioration requires replacement of a distinctive feature, the new feature will match the old in design, color, texture, and, where possible, materials. Replacement of missing features will be substantiated by documentary and physical evidence.
7. Chemical or physical treatments, if appropriate, will be undertaken using the gentlest means possible. Treatments that cause damage to historic materials will not be used.
8. Archeological resources will be protected and preserved in place. If such resources must be disturbed, mitigation measures will be undertaken.
9. New additions, exterior alterations, or related new construction will not destroy historic materials, features, and spatial relationships that characterize the property. The new work will be differentiated from the old and will be compatible with the historic materials, features, size, scale and proportion, and massing to protect the integrity of the property and its environment.
10. New additions and adjacent or related new construction will be undertaken in such a manner that, if removed in the future, the essential form and integrity of the historic property and its environment would be unimpaired.

Images



Figure 1. Quechee Gorge Bridge shortly after construction, in 1911.

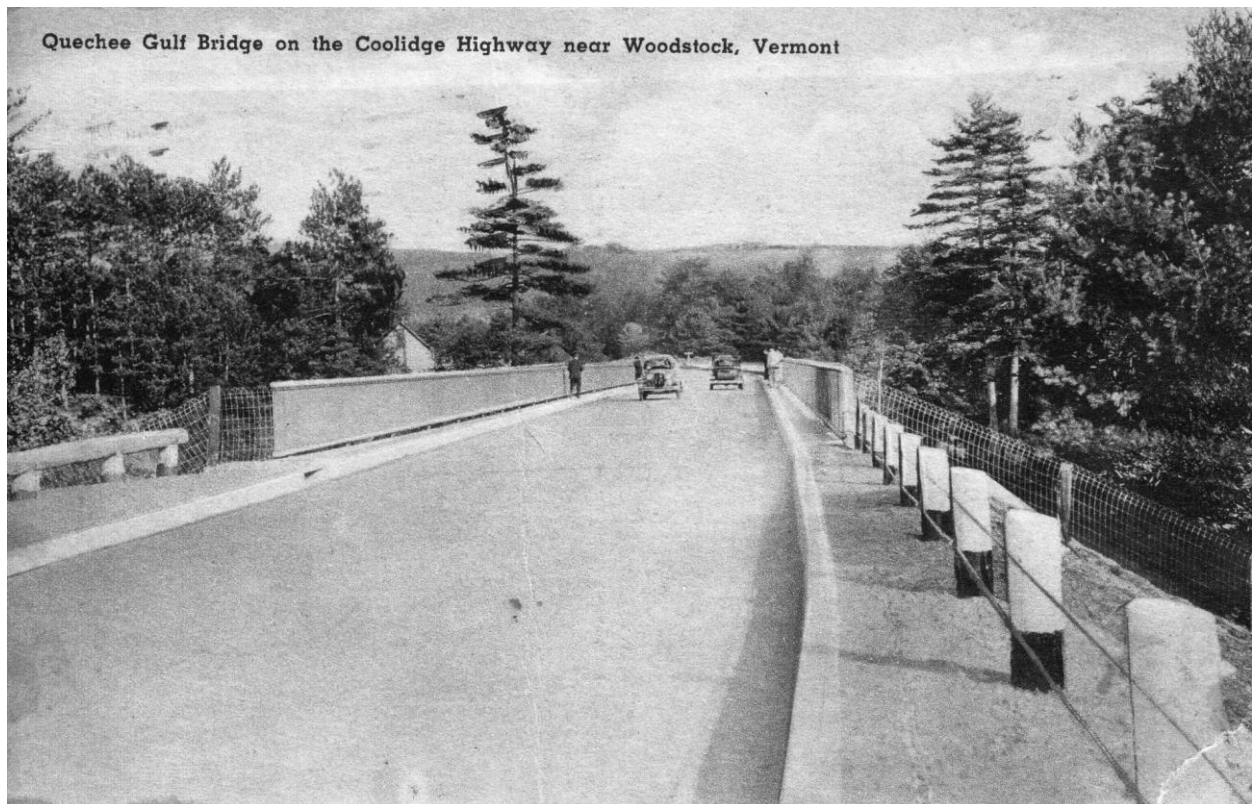

Figure 2. Quechee Gorge Bridge converted to automobile use, around 1933. Image is looking east on US Route 4.

**Quechee Gorge Bridge Suicide Prevention Study
Public Meeting
Wednesday, November 16, 2016 6-8PM
Hartford Town Hall, 171 Bridge Street, White River Junction, VT 05001**

The public meeting was for the purpose of providing an overview of the Quechee Gorge Suicide Prevention Study, related work currently happening at the Bridge, and to give the public the opportunity to ask questions and provide input to the process. Relevant plan documents will be available for review at the Hartford Town Office (171 Bridge Street, White River Junction) and online <http://vtrans.vermont.gov/planning/projects-programs>. The information received will be considered as the Agency prepares draft Quechee Gorge Bridge Suicide Prevention Study and final Legislative Report. Comments will be accepted until 12/16/16 and should be submitted via email to Jackie.Cassino@vermont.gov or via mail to:

Jackie Cassino, Planning Coordinator
Vermont Agency of Transportation
1 National Life Drive, Davis Building, 5th Floor
Montpelier, Vermont 05633-5001

Meeting Notes:

Transportation Bill specifics

- Section 38 of the 2016 Transportation Bill – Quechee Gorge Bridge Safety Issues, tasks VTrans with two tasks.
 1. “...completing a project on or proximate to Bridge 61 on US Route 4 to install a structure providing information and resources, signs, or communication devices, or some combination of these, aimed at preventing suicides at the bridge.”
 2. To work with the Agency of Commerce and Community Development, the Department of Health, the Department of Mental Health, the Department of Public Safety, local officials, local emergency personnel, the Hartford Area Chamber of Commerce, mental health practitioners, local business owners, and other interested stakeholders, the Agency of Transportation shall thoroughly review suicide prevention as well as pedestrian, first responder, and other safety measures that could be taken, and the merits of taking such measures, at the Quechee Gorge Bridge. Specifically- the report will identify-
 - Options for physical improvements to the bridge structure and surrounding area as well as non-infrastructure related safety improvement measures that can be taken in the area
 - Cost estimates and expected timeline for implementation measures
 - Economic, community and tourism concerns associated with the measure

Project Overview

-Starting in May of 2016, VTrans reviewed testimony on this matter provided during the last legislative session, conducted our own literature review of national and international best practices as well as engaged national transportation professionals and research professionals on the subject matter.

-VTrans identified relevant case studies where other state DOTs or bridge authorities have tackled similar issues.

-VTrans began engaging local stakeholders and mental health professionals to begin working to addressing those two tasks- and held two local meetings to specifically discuss how to best address Task 1. The following organizations/individuals have been involved: Hartford municipal staff, police, fire & rescue; local Chamber of Commerce and business owners, the regional planning commission, Windsor County Partnership, the Vermont Department of Health- District Health Office, Vermont Suicide Coalition, Hartford Community Coalition, local high school guidance programs, Vermont Department of Mental Health, and Dartmouth Hitchcock Medical Center.

-Beginning in July- VTrans began providing regular updates on the work to local stakeholders engaged in this- approximately twice monthly

-Emergency call boxes and associated with signs depicting vetted messages of hope- are scheduled to be installed late November, 2016.

-In August, VTrans hired the transportation planning and engineering firm DuBois & King and the Vermont Suicide Prevention Center to assist with Task 2.

-Study will be completed in December of delivery to the Legislature in January. The Legislature will then determine the timeline for next steps.

Presentation by Lucy Gibson, DuBois & King

-Presentation can be reviewed here: <http://vtrans.vermont.gov/planning/projects-programs>

Comments/Questions

1. What is the working timeline
 - a. Study must be completed in December for delivery to the Legislature
 - b. The Legislature will determine the timeline for next steps
 - c. If a project were to move forward it would take time to program the project in the AOT Capital Program, go through the permitting process, and the project development process
2. Is there a ball park figure regarding the cost of the Alternatives
 - a. Consultants are working on getting those together. Can generally estimate that the vertical barriers would be the most expensive upfront- as the bridge sidewalk and railing would need to be rehabbed as well. The nets would be less expensive to install, but with a potential maintenance cycle dictating replacement every 5 years, the cost savings may be minor.
 - b. If sidewalks and street lighting would add a lot of money to the barrier options
 - c. Construction cost estimate, maintenance costs, timing of permitting, design, construction will all be available in the Legislative Report

- d. The netting looks like it will be much more cost effective due to the fact that it could be done without replacing the sidewalk
- 3. Does the net option require any changes to the current railing
 - a. No
- 4. What is the deficiency in the current railing
 - a. The current railing does not meet the new standards for a pedestrian and vehicle railing
 - b. If it were to be removed it would have to be replaced with an upgraded railing which would meet the new standard
 - c. The new standard would require a 4 bar galvanized steel rail
 - i. As a traffic rail it would be either 2'9" high or 3' high
 - ii. In this case the traffic barrier would be lower than the existing bridge rail
 - iii. There would then be a high outer railing on the bridge
 - d. Although the current barrier does not meet current standards it is not unsafe
 - e. If the nets were installed there would be no need for changing the pedestrian barrier
 - f. If the barrier method were used instead of the netting option then the barrier method would require that the sidewalks be redone and the interior traffic barrier would be required
- 5. Regarding Bridge maintenance (Washing and Painting)
 - a. A bucket truck is typically used, could a bucket truck still be utilized?
 - i. Several of the tall barriers would be removable so that the bucket truck could be used
 - ii. Also, rescue teams would need to have barrier sections removable
- 6. Do the nets trigger an alert
 - a. Yes, they do have motion sensors
 - b. Hartford PD could check the nets as a part of their regular patrol of the area
- 7. On the vertical barrier – why 6" not 8" between the vertical barriers
 - a. At the lower levels 6" are required as per federal and state standards, there would be a potential to then transition to a wider space higher up
- 8. Comment regarding the number of deaths
 - a. There have been a number of incidents at the bridge over the past several years
 - b. It is a lot of money to prevent events which may not be preventable
 - c. Folks find other locations/options if they want to pursue
 - d. What about running an observation tube under the bridge
 - i. Get the pedestrians off the bridge
 - ii. Do a massive project for the largest tourist attraction in the area
 - e. Jackie response:
 - i. Studies have shown that barriers do prevent suicides
 - ii. Adjacent bridges to bridges where barriers have been installed do not see rises in suicide incidents
 - iii. Early 2000's planning study with a similar configuration with an observation area –was determined to be cost prohibitive
 - iv. This is a historic structure and it would be incredibly difficult to permit that sort of alternation from a historic preservation perspective- as it would require alteration to the bridge arches
- 9. If you can put a price tag on my son's life, then go ahead
 - a. The Medical Examiner's office was only collecting data back to 2003- so this study is not considering the deaths before 2003
 - b. First responder risks should also be considered

- i. Both physical recovery risks and mental health impacts
 - ii. Financial cost of rescue and recovery operations
- 10. What would the impact of the netting on wildlife be (related to the nearby VINS facility)
 - a. Unsure at this time
- 11. This bridge is not even on the Agency's programmed construction list – it could be 20 years
 - a. We are in the beginning stages of planning for improvements
- 12. What is the input from first responders regarding the 2 options
 - a. A lot of concern regarding the net's impact of a rescue operation initially- according to the PD and Rescue staff- they are accepting of which ever method is chosen, so long as they have vertical access to the Gorge.
 - b. Cornell's nets are retractable to improve access for maintenance and emergency responders
- 13. Should consider the costs of investment would be amortized over a long period of time – relative to the costs per life lost
 - a. From a safety perspective this would easily be cost effective how those benefits are measured
 - b. There are also maintenance costs to be taken into account
- 14. You have done a good job with this analysis
 - a. For those who do business or work at the gorge – the bridge is the destination
 - b. The Agency needs to address what they do for their business mission but the business community at the bridge is directly impacted by the day to day count of visitors
 - c. The wonder of the opportunity needs to be preserved
 - d. Let's move forward together
 - e. If the solution decreases the flow of people who want to come – that would be an issue
 - i. The impact of social media has a huge impact and is time sensitive
 - ii. How can we potentially increase the attraction of visitors!
 - f. If both of these solutions work then let's find a way to move forward with one of them, with the economic/tourism/visual impacts in mind
 - g. There may be other technological changes (light, sound, voice, recorded sensor driven devices) that could be around the corner
- 15. Historic Steel Arch Bridge – highest in the State of Vermont
- 16. Are the barrier and netting equally effective in suicide prevention
 - a. Yes
- 17. Rescue Operations
 - a. Fire Chief indicated that either option would be workable for the fire/rescue community
 - b. The training materials used by the Ithaca Departments have been reviewed and could be implemented here
- 18. Would people climb out of the net and try to continue their pursuit
 - a. Interviews with survivors indicate that folks who jump into the net have a wakeup call and realize that they regretted their impulse to jump
- 19. When would someone find the person in the net
 - a. Having sensors that would trigger a response is going to be critical
 - b. Having lighting sounds like it is also very important
 - i. About half of the events were at night- ¾ total if consider early AM hours as well
 - ii. In Japan gorge bridges are now being lighted and are analyzing pre-lighting versus post lighting
 - 1. Initial indications are that the lighting is reducing the incidence of jumping

20. What amount of funding is going to be need to be spent on this bridge in the next several years
 - a. There are no structural deficiencies which would indicate that the bridge would be needing to be rehabbed or replaced any time in the near future
 - b. We inspect our bridges every two years
 - c. Bridge 179 out of 833 on the bridge inspection condition rating
 - d. How many bridge are worked on each year (this may be an important piece of information to include in the report)
 - i. Maintenance
 - ii. Rehab
 - iii. Reconstruction
21. What will be addressed in the report – Lucy reviewed the criteria
22. Kip Miller – Gift Shop Owner – 36th season, owner since 1980
 - a. The inside rails of the bridge have been used on the bridge since at least 1980
 - b. His survey of business owners in the area of the bridge favors the netting solution
23. Gary Neale – Quechee Gorge Village
 - a. The people who come look forward to an outdoor recreational adventure
 - i. Looking at the bridge from the side
 - ii. From the dam
 - iii. From the bridge
 - b. How does it look, how does it make you feel, what are you saying about it on social media
 - c. Even with netting, it could still be a wonderful experience for a relatively
24. PJ Skeehan – Visitor’s Center/Hartford Chamber
 - a. We don’t want this known as a suicide bridge
 - b. Something needs to be done
 - c. Sending out initial emails folks think netting is likely more aesthetic
 - d. This is a big tourist attraction
 - e. The trails are also popular
 - f. Each suicide is traumatic for the folks that work near the bridge – and of course the families
 - g. We need to look for a solution that prevents suicide and increases visitors
 - i. Spend more money on marketing to attract more visitors
25. Alison Clarkson
 - a. What is the cost for rescue/retrievals
 - b. Leo Pullar - Town Mgr
 - i. Salaries of responders, likely overtime if it goes beyond one shift
 - ii. No nighttime responses but staff need to be on the bridge to secure the scene
 - iii. Aftercare for first responders
 - iv. Estimate of approximately \$20K per rescue (this should be included in the report)
 - c. Police Chief Kasten- should also consider the ongoing costs associated with the rescue operations
 - i. Police investigation costs
 - ii. Medical examiners costs
 - iii. Police social worker costs
 - iv. Specialized rescue equipment costs
 - v. Potential injury of rescue workers

26. Scott Farnsworth- Local high school principal/former Guidance Director of the HS – Hartford Community Coalition member
 - a. When Hartford becomes a community that care, cost doesn't really matter
 - b. When there is an OD, we care and come together to figure out a solution
 - c. We have a structure that was created by mankind – what do we do
 - d. I appreciate the netting, this could be a win-win
 - e. Let's continue to have these conversations and work together
27. Alison
 - a. The AOT is putting together the budget right now – they can make it a priority – they have the opportunity to make it a priority
 - b. The Legislators can also make it a priority as they work on the T Bill
28. Regie Cooper
 - a. The town is paying for the cost of the rescues
 - b. The statistics indicate that these are folks from all over the state and out of states
 - c. The bridge is becoming known as a suicide hot spot and people are coming
29. Police Chief
 - a. Could we potentially get grants for street scape enhancements- yes
 - b. Alison indicated that the historic nature of the bridge could attract funding – like through Paul Bruhn
 - c. Minor damage accidents are not all being recorded (occurrences on the bridge) – there are likely a high number of these
 - d. Pedestrian and vehicle safety which could be enhanced by improvements to these facilities on the bridge
30. Pedestrian Crossing
 - a. By the Visitors Center there is a lighting system which is not being as well recognized as it could be
 - b. The speed flasher signs are somewhat helpful in slowing folks down
 - c. Traffic moves very quickly through this area
 - d. There is driver distraction on the bridge due to observing the views
31. Netting
 - a. Would this be shovel ready
 - b. No need for structural changes to the bridge
 - c. Would need to be installed in a manner which would be consistent with preserving the historic resource

Recap of Next Steps and Meeting Adjourns 7:48PM

Quechee Gorge Bridge Suicide Prevention Barrier Study

Michelle Boomhower and Jackie Cassino,
VTrans

Lucy Gibson, PE and Robert Durfee, PE
DuBois & King



About this study

- Initiated by VTrans based on legislation passed in 2016:

AOT is required to:

...thoroughly review suicide prevention as well as pedestrian, first responder, and other safety measures that could be taken, and the merits of taking such measures, at the Quechee Gorge Bridge. The review will identify:

- 1) short- and long-term suicide prevention as well as pedestrian, first responder, and other safety measures for all users that could be taken, including:
 - a) providing information and resources, including emergency contact information and means of emergency communication; and*
 - b) physical improvements to the bridge structure and the surrounding area;**
- 2) estimated costs and benefits and an expected timeline associated with implementing the measures identified*
- 3) economic, community, and tourism concerns associated with implementing the measures identified in subdivision (1) of this subsection.*

Study Advisory Committee

- VT Agency of Transportation
 - Structures,
 - Operations,
 - Traffic safety,
 - Policy and Planning,
 - Environ'l Permitting
- VT State Parks
- VT Historic Preservation
- VT Department of Health
- US Army Corps of Eng's
- Town of Hartford
 - Police,
 - Fire,
 - DPW,
 - Community Development,
 - Town Manager
- Two Rivers-Ottauquechee Regional Planning Commission

3

Tonight's Meeting

- Review site conditions
 - Quechee Gorge State Park
 - Quechee Gorge Bridge
- Case studies
- Alternatives
- Discussion

4

QUECHEE GORGE STATE PARK

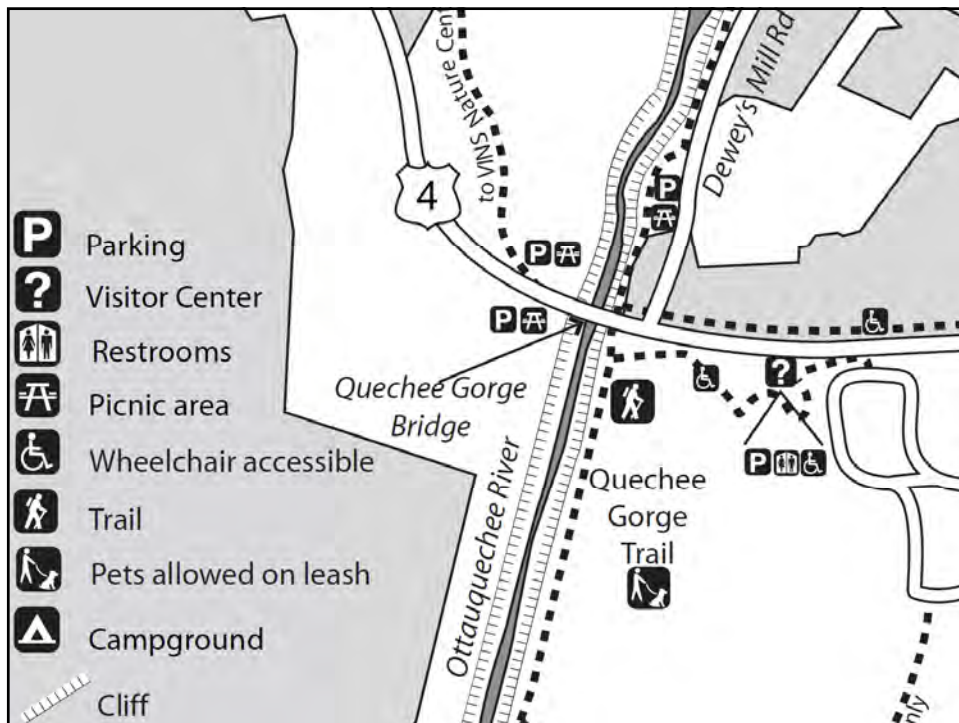

How many visit the gorge?

- Visitor Center has over 100,000 visits per year
- By far the highest day use compared to other state parks
- Hub of economic activity

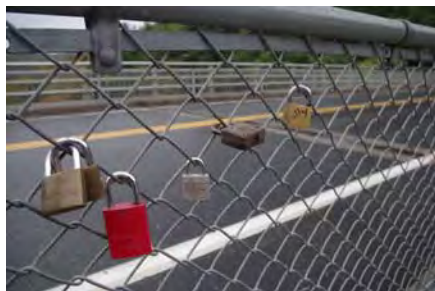
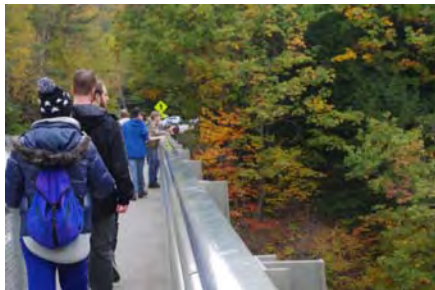

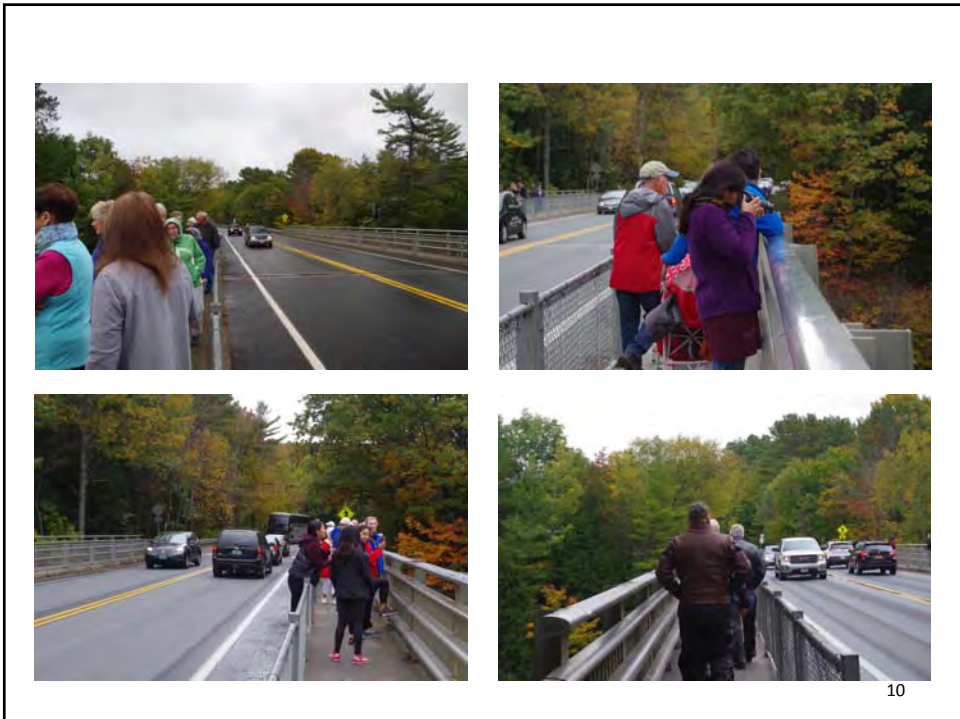

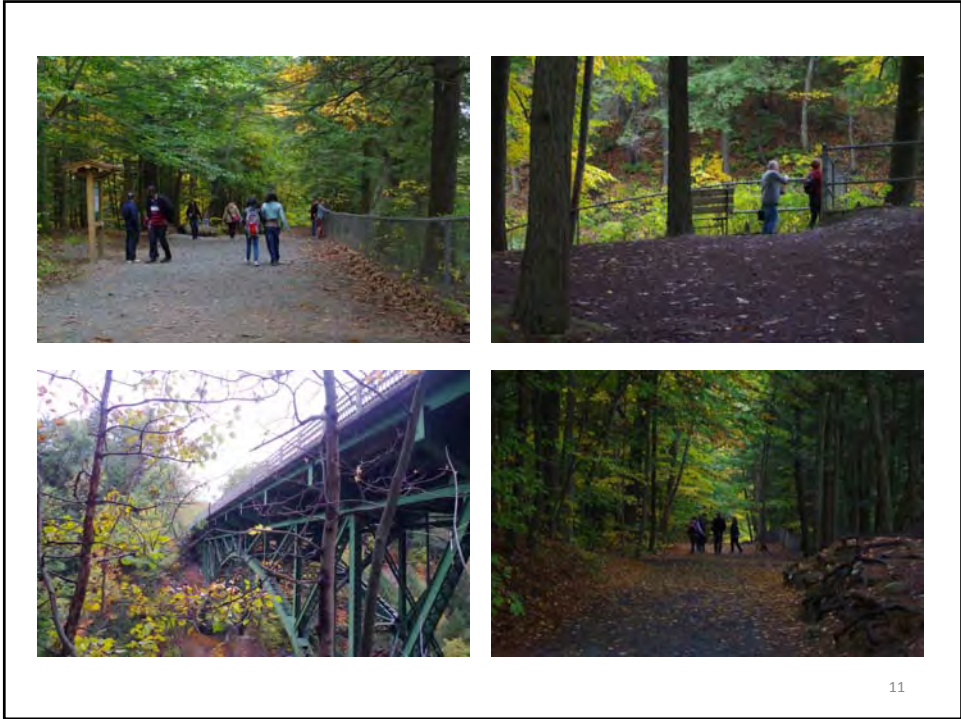

11

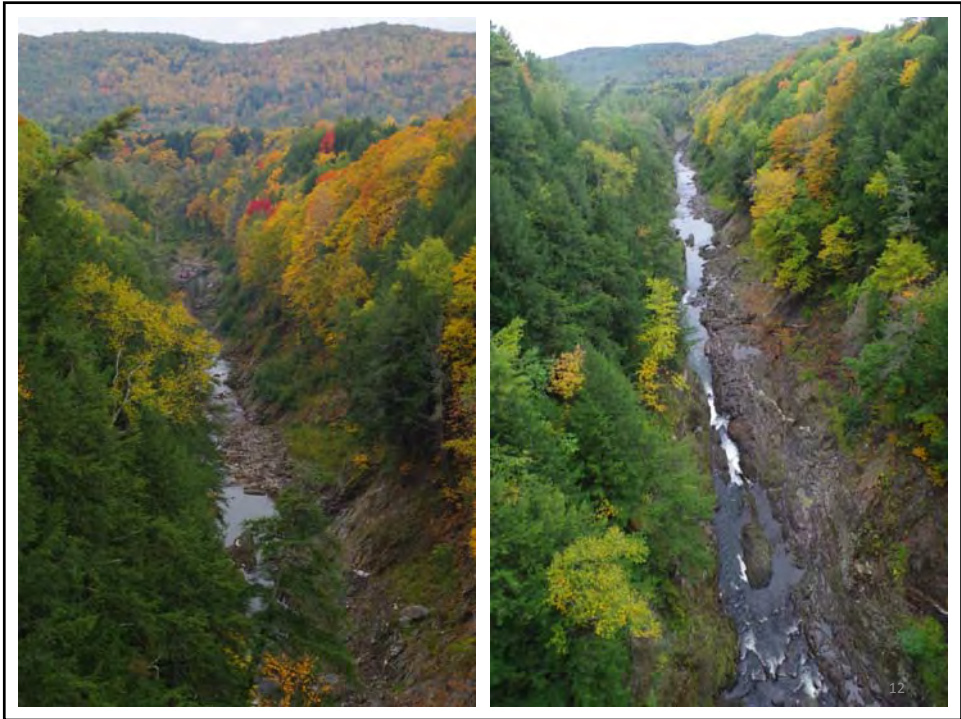

12

QUECHEE GORGE BRIDGE

Quechee Gorge Bridge: US 4

- Length = 285 ft; Depth of Gorge = 165 ft
- Traffic Volume = 9,000 vehicles per day
- Traveled Way Width
 - 12 ft lanes
 - 3 ft shoulders
 - Existing railings added in 1972
 - Railings do not meet current standard



Quechee Gorge Bridge: Sidewalk

- Added in 1972, with bridge rail and removable barrier at curb
- 3.5 ft wide; does not meet ADA guidelines

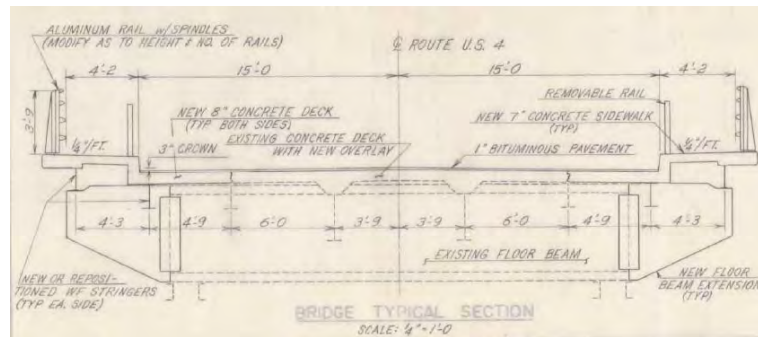

15

Bridge Cross Section-Existing

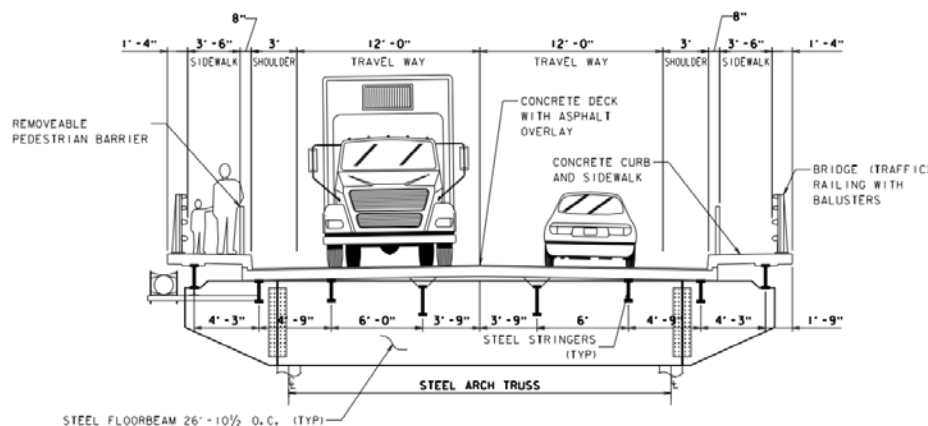

16

Historic Bridge

- Built in 1911 for the Woodstock Railroad
- Listed on the National Register of Historic Places

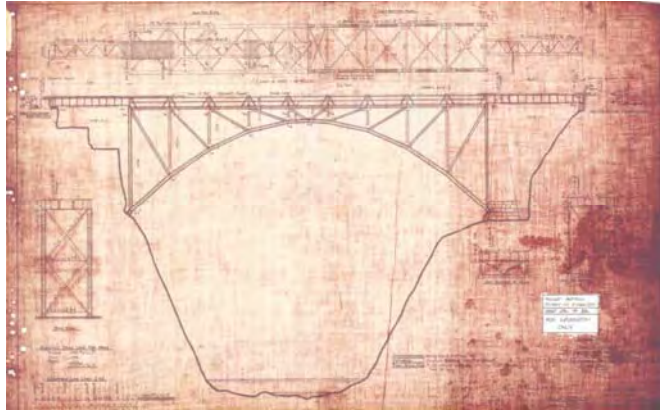

Crashes

- 33 crashes on bridge 2010 to 2016
- Many rear enders, few injuries



QUECHEE GORGE BRIDGE SUICIDES

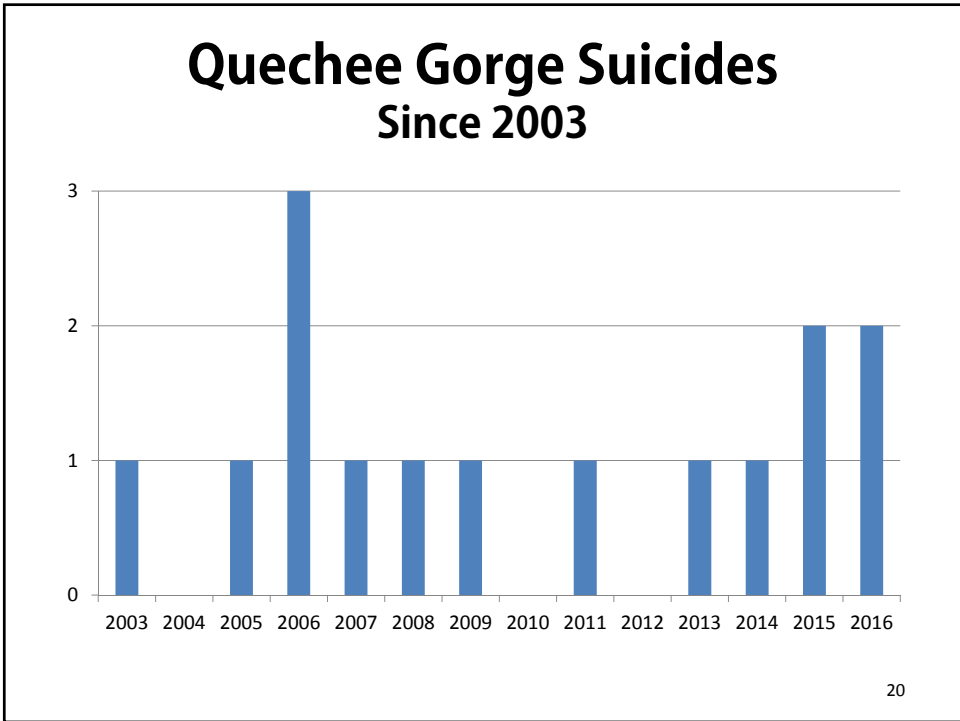

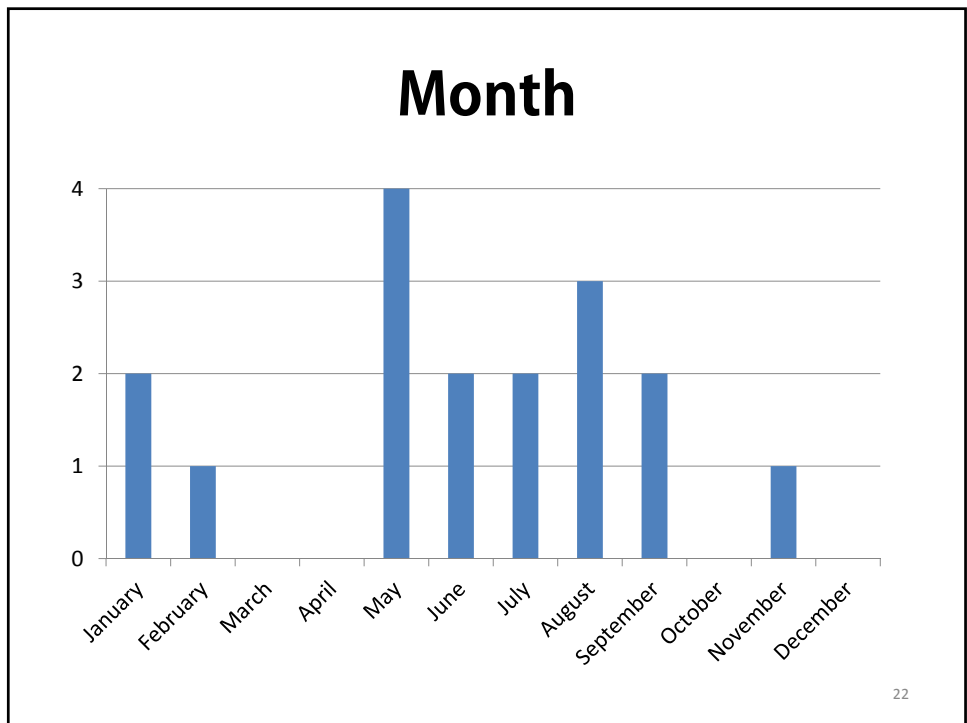
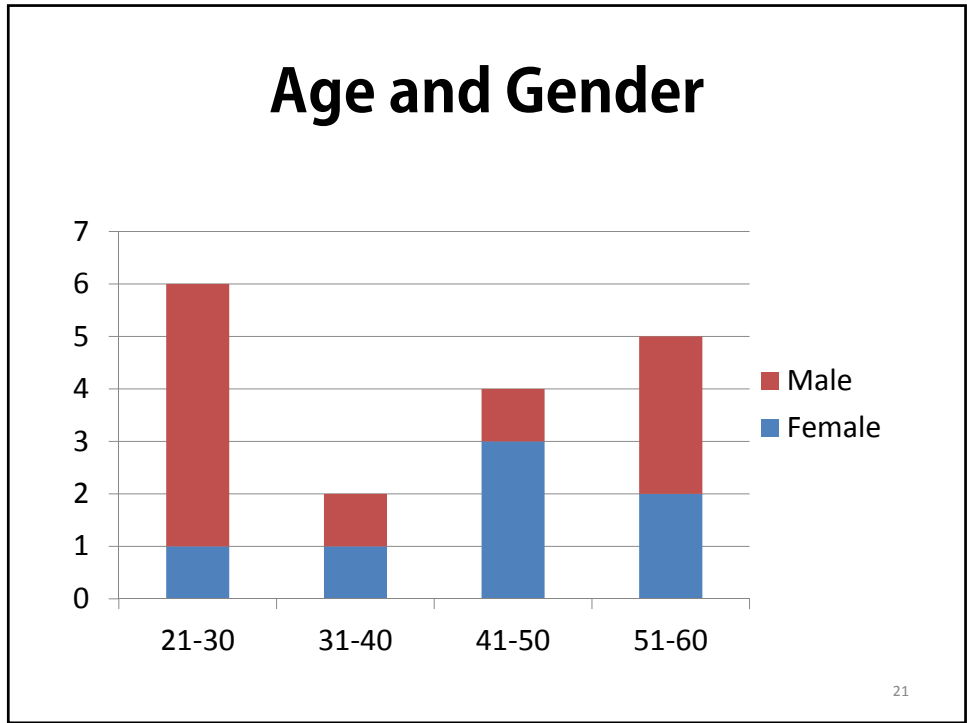

Means Restriction for Bridges

DATA AND CASE STUDIES

Barriers or “Means Restriction” on Bridges



Barrier Types

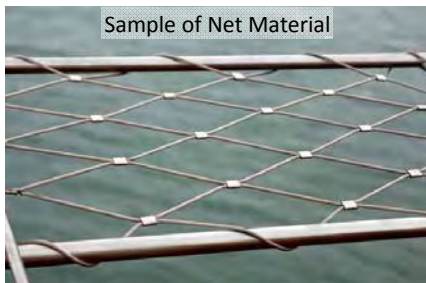
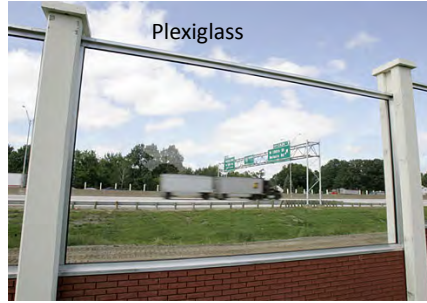

Case Studies

- Duke Ellington Bridge, Washington DC
- Memorial Bridge, Augusta ME
- Cornell/Ithaca Gorge Bridges, Ithaca, NY

Duke Ellington Bridge



Pre-barrier vs. Post-barrier Suicides

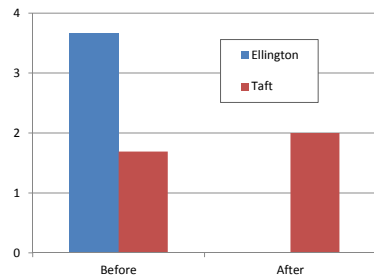

Mean Annual Suicides-DC Region

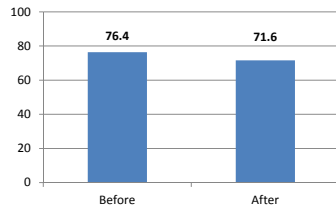

- No increase at Taft Bridge after installation of barrier
- Regional suicide rate declined after barriers

Memorial Bridge, Augusta, ME



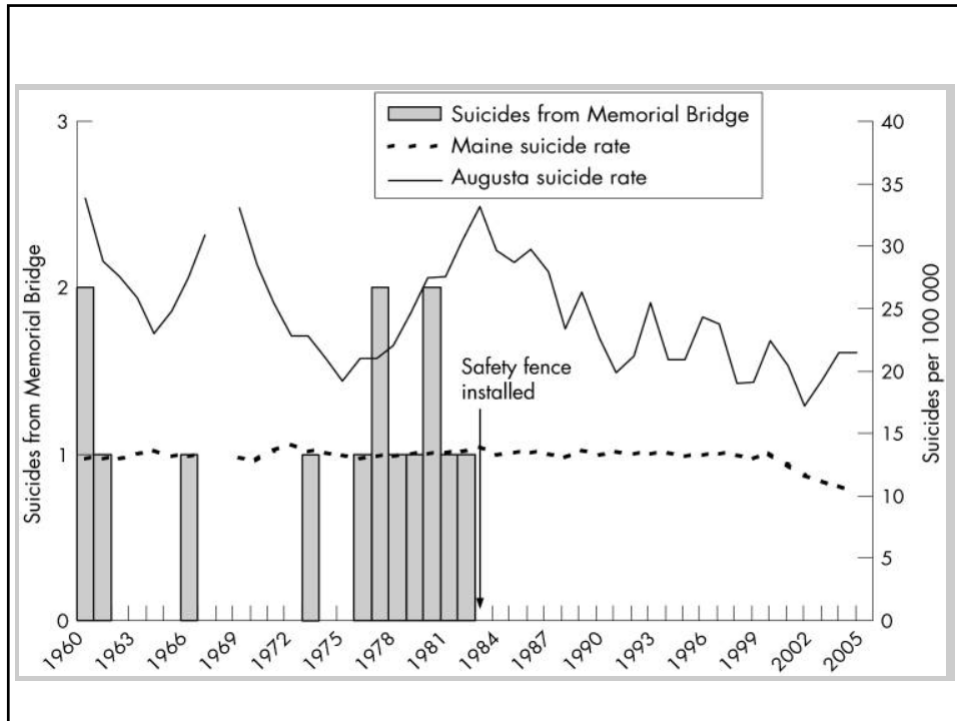

Memorial Bridge, Augusta

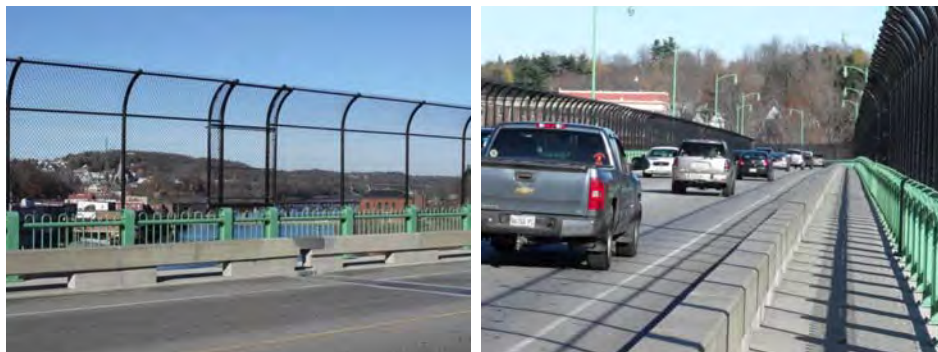

Ithaca NY Gorge Bridges

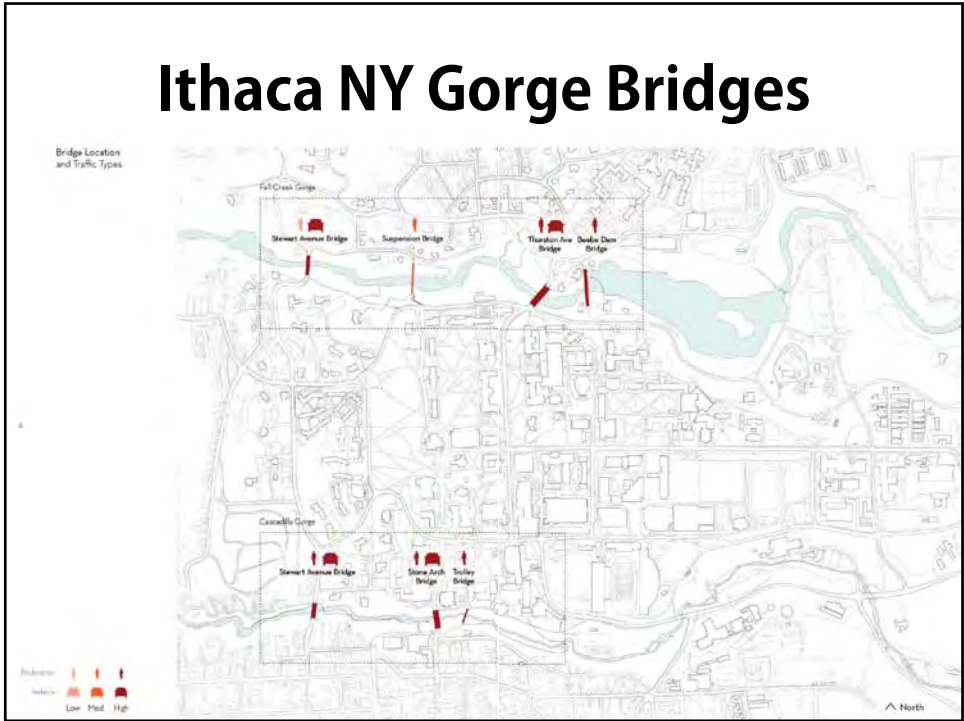

Chain Link barriers - 2010



Nets replaced barriers 2012



35

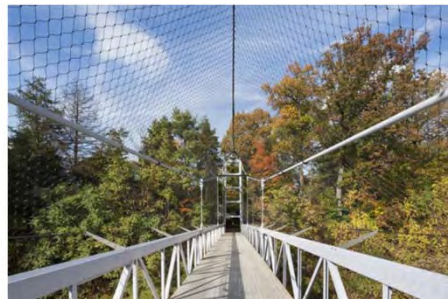

Summary

- Bridge barriers have been proven to be highly effective in preventing suicides and save lives.
- By deterring an attempt, the person in crisis is given more time for their period of crisis to pass.
- Suicide barriers have high benefit to cost ratio.

ALTERNATIVES

Alternatives

- 1) No Action on bridge
 - Increased Information and Resources
 - Lighting
- 2) Suicide Prevention Barrier
- 3) Suicide Prevention Nets

39

1) Increased Information and Resources



Add street lighting to parking areas

Call Boxes to be installed November 2016
Consider street lights at parking area

40

2) Suicide Prevention Barrier

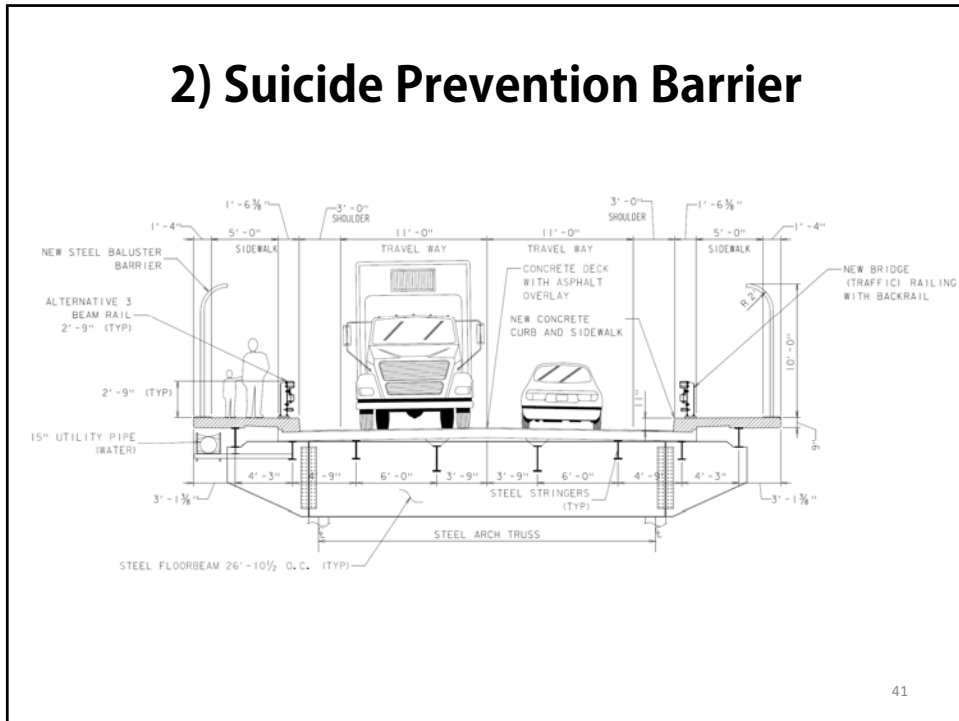

3) Suicide Prevention Net

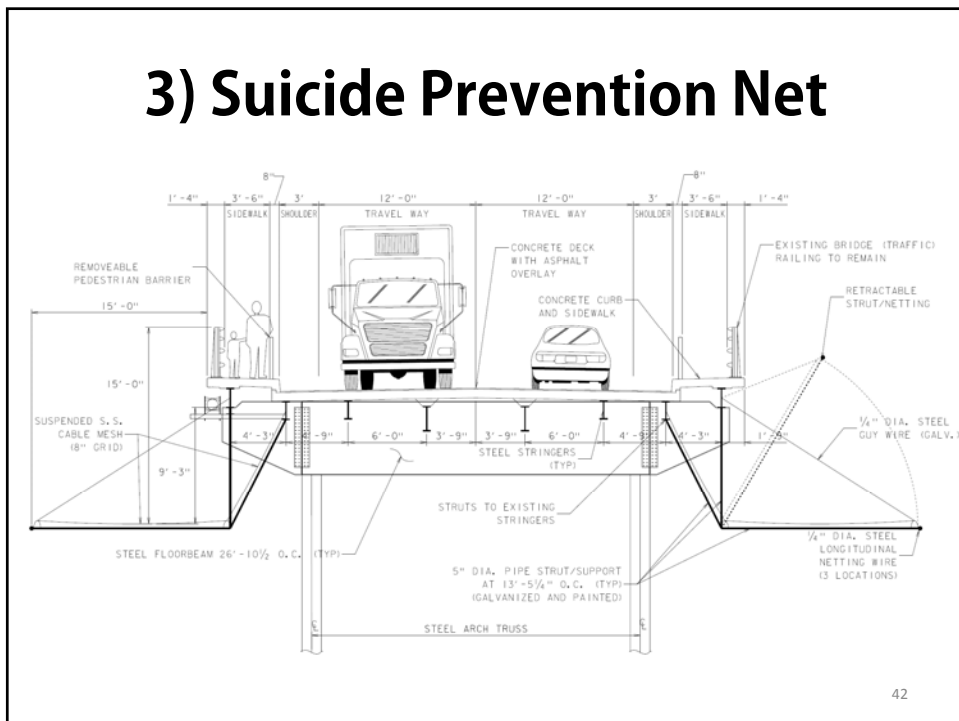

VISUAL IMPACTS

43

Viewshed Impact: Barrier



44

Viewshed Impact: Barrier

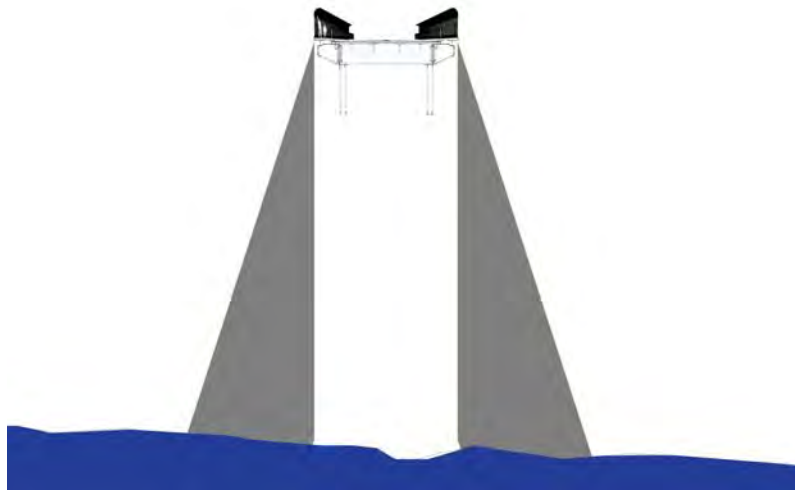

45

View from Sidewalk

- Nets will not be visible for people walking on the sidewalk

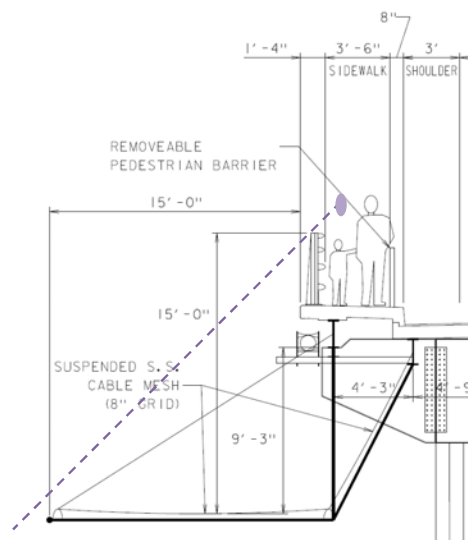

Viewshed Impact: Net

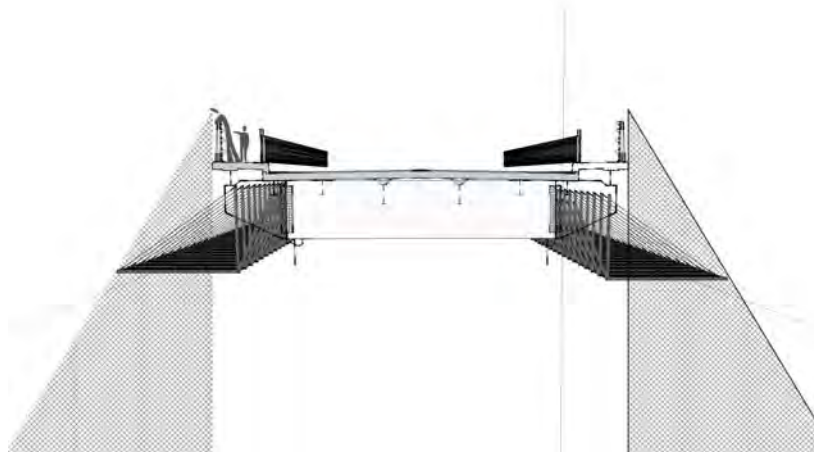

47

Viewshed Impact: Net

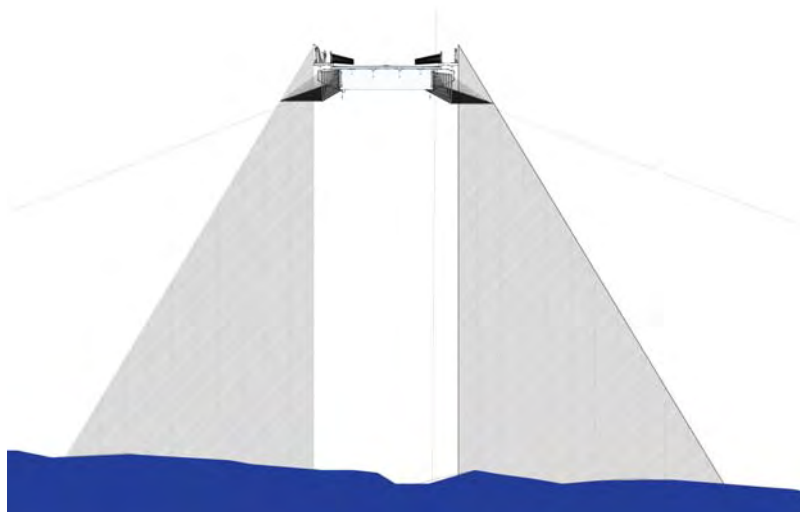

48

Viewshed Impact: Barrier



Visual Impact: User Perspectives

- From automobile
- From sidewalk
- From trails

View from automobile



51



52









View from Sidewalk



View from Sidewalk





63

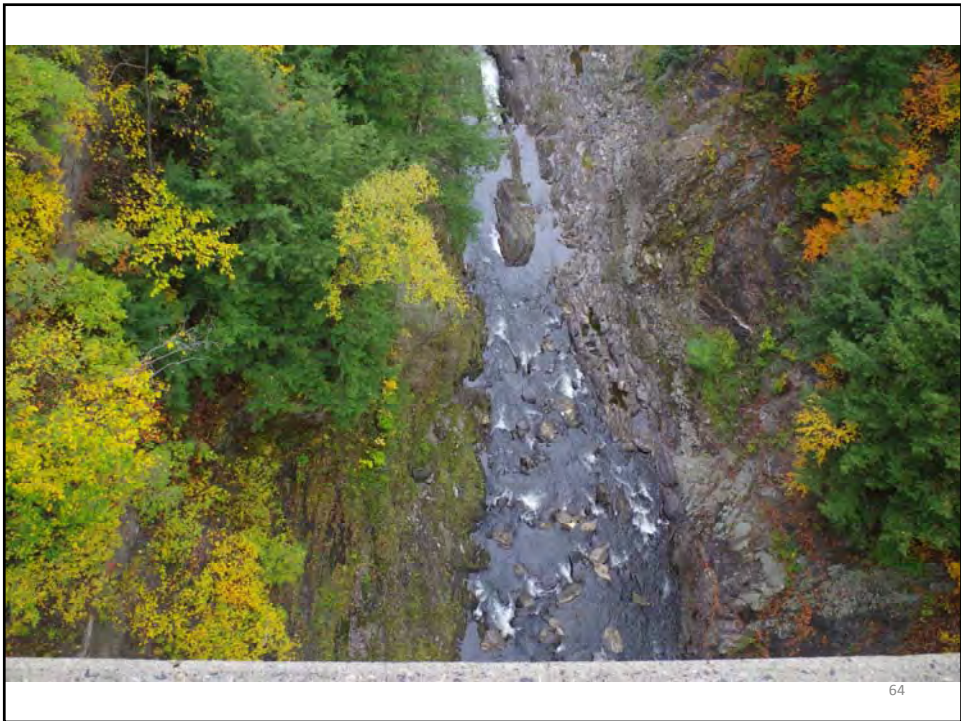

64



View from Trails











QUESTIONS?

75

Design Considerations

- Effectiveness in suicide prevention
- Impact on the community
 - Appearance of barrier
 - Transparency/Compatibility with viewing gorge
- Impact on bridge structure and load rating
- Emergency response considerations
- Maintenance requirements
- Cost

DISCUSSION

77

Next Steps

- Continue research and design refinements
- Develop cost estimates for construction
- Evaluate maintenance, emergency response considerations with Town and State officials
- Develop implementation plan and timeline
- Prepare Final reports by December 23, 2016 for legislature

Thank You!

Comments to Jackie Cassino by
December 16

Jackie.Cassino@vermont.gov

79

**Quechee Gorge Bridge Suicide Prevention Study
Working Group Kick-Off Meeting**

AGENDA

Friday, September 23, 2016 10:00 -11:30 am

Conference Room 313, 3rd Floor, National Life Building, Montpelier, VT

- 10:00 Welcome- Jackie Cassino, VTrans
-Welcome and introductions
-Roles/expectations moving forward
- 10:15 2016 Transportation Bill-Michele Boomhower/Jackie Cassino, VTrans
-Context overview
-Review of Section 38: Quechee Gorge Bridge Safety Issues
-Work accomplished to date recap
- 10:30 Quechee Gorge Bridge Suicide Prevention Study -Lucy Gibson, D&K
-Review scope and schedule
-Literature Review/Case Studies
-Site Visit, Relevant data Review
- 11:20 Wrap up & Adjourn-Jackie Cassino, VTrans
-Review next steps

Directions & Logistics

From I-89: Exit 8. After exiting, you are on Memorial Drive. At the first traffic light, take a right onto National Life Drive. Go up the hill past the building to the main entrance on the left; park in the unrestricted areas (see attached map); the VTrans offices are in the Davis Building (eastern part of the building).

From Montpelier: take a left at the last traffic light before I-89 (just past the Dept. of Labor & GMP facilities on the right) onto National Life Drive. Go up the hill past the building to the main entrance on the left; park in the unrestricted areas (see attached map); the VTrans offices are in the Davis Building (eastern part of the building).

The meeting will be held in the Davis Building at the National Life Campus in Montpelier- in conference room 313 (3rd floor). Non-state employees will need to check in with security in the Davis Building Lobby. Security will then let you into the main part of the Davis Building where you can take the elevator or stairs to the 3rd floor (see attached 3rd floor directory).

Questions? Contact Jackie Cassino jackie.cassino@vermont.gov, 802-272-2368.

Attending:

Lucy Gibson (DuBois & King)
Robert Dufree (DuBois & King)
Jackie Cassino (VTrans-PPAID)
Michele Boomhower (VTrans-PPAID)
Todd Law (VTrans-MOB)
Wayne Symmonds (VTrans-Structures)
Patti Coburn (VTrans-Highway Safety & Design)
Dr. Jaskanwar Batra (VT Dept. Mental Health)
Devin Colman (VT ACCD- Hx Preservation)
Frank Spaulding (VT Dept. Forests, Parks & Recreation)
Heather Morse (USACE)
Karl Hakala (USACE)
Phil Kasten (Hartford Chief of Police)
Whitney Hussong (Hartford PD)
Jennifer Chambers (HCRS)

Meeting Notes:

- Project overview/relevant background information/Transportation Bill language.
- Review of project scope/schedule- legislative report based on this study due in early January
- Discussion/Review of barrier options and case studies. Two primary options:
 - Barrier railing/fence. 9-12' high, designed to prevent climbing, spacing <6". Replace existing bridge rail with new system or add barrier onto existing rail bridge
 - Nets. Allow for distant views. Challenges identified with maintenance as well as rescue operations.
 - Case studies: Aurora Bridge, Seattle, WA; Ithaca NY nets; Vista Bridge, Portland, OR; Golden Gate Bridge, CA; Ironworkers Memorial Bridge, Vancouver, BC
 - Other examples to explore mentioned:
 - Claiborne Pell Bridge, Newport RI (aesthetics/viewshed)- no barriers put up at this time.
 - Woodrow Wilson Memorial Bridge, Alexandria, VA & Oxon Hill, MD-northern span of bridge includes ped and bike passage accommodations (12' wide path 1.1 miles long), separated from traffic by safety barriers. In addition, this section also has bump out areas where for user viewing. This bridge was more an example to demonstrate a separate bike/ped configuration- not an example with a barrier for suicide prevention.



- Bloor Viaduct, Toronto. From 1918-2003- more than 400 people lost their lives by jumping from the bridge. In 2003, the City of Toronto added a \$6 million safety barrier.



- Duke Ellington Bridge, Washington, DC. 3 arch concrete structure, 825' long and 60' wide roadway framed by 12' sidewalks with pedestrian lookouts. 1974-1985 24 deaths from jumping occurred. 1986- 8' high fence completed costing \$229,000.



-Discussion regarding the unique nature of the Quechee bridge as a tourist destination in a rural setting. Not too many other examples of this in the literature – some similarities in the Golden Gate Bridge with regards to tourist destination.

- Quechee Gorge Bridge specifics (Bridge #61):
 - 3 hinge steel deck arch bridge. Historic bridge- listed on the National Register for Historic Places built in 1911 for the Woodstock Railroad.
 - Bridge reconstructed in 1989
 - Structure length is 285'; 2 travel lanes
 - Currently, sidewalk configuration does not meet ADA standards. In order to provide wheel chair traffic with an ADA accessible route across the bridge, the bridge sidewalk must provide a minimum clear width of 60" passing areas at least every 200'.
 - Roadway typical:

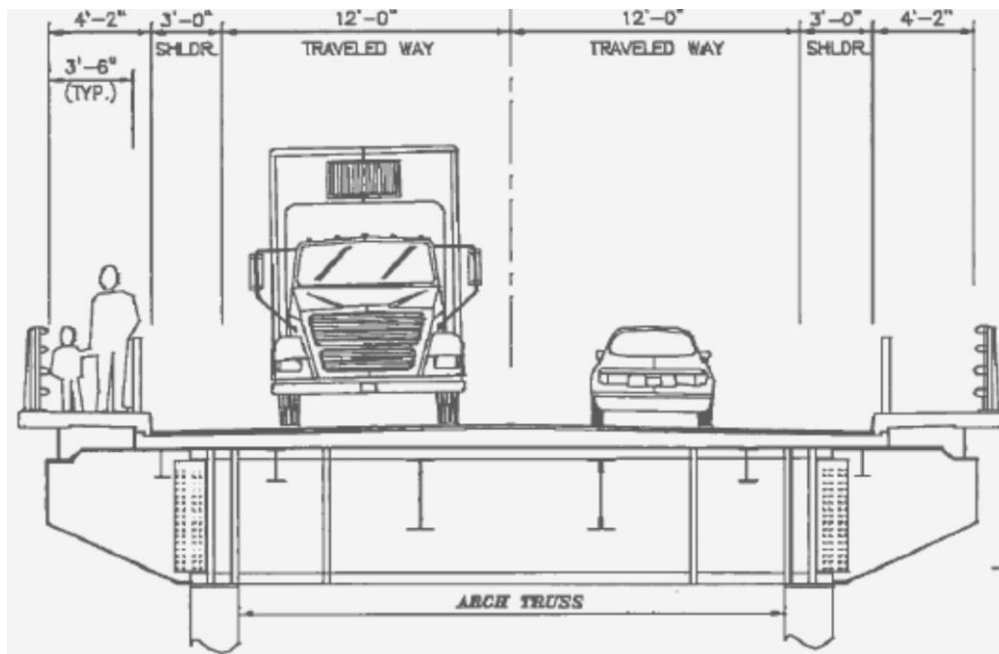

- As part of the analysis, the consultants will analyze aesthetics for any proposed structure from the perspective of both the pedestrian and the driver. Discussion from Hartford PD Chief Kastan regarding concerns of distracted driving. Recommended looking at crash data. Local PD reports often of minor- rear end collisions due to distracted driving and conflicting bridge users (i.e. cyclists in travel lane, pedestrians on sidewalks, not crossing at designated crosswalks, multiple parking options on either bridge approach).
- Reviewed 2015 State Bridge Inspection Report. Currently, no project (maintenance or otherwise) is programmed for this bridge. There are some funds available for preservation related work as this is a historic bridge.
- Typically, VTrans would not replace an existing railing until the structure deck needs replacing.

- According to the local PD and Emergency Rescue, in recent years there have been 2 attempts to jump from the gorge ledges and not the bridge. Both times, emergency personnel were able to prevent person from jumping.
- Discussion as to whether or not there is the opportunity to narrow the travel lanes. For maintenance purposes- the ideal widths VTrans aims for is 14'-15' between the travel land and the shoulders- Vermont State Roadway Standards identify design requires an 11' travel lane and a 4' shoulder.
- Currently, the vertical separation/pedestrian barriers are removed for winter maintenance. Vertical separation of sidewalk from travel lane is key.
- Discussion regarding option for a separate pedestrian "tunnel" at different grade than travel lane on one side of the bridge, built off of the main bridge structure- similar to the Woodrow Wilson Memorial Bridge. The road shoulders could then accommodate cyclists, while pedestrians would have a separate facility to utilize on one side of the bridge. The other side of the bridge would not accommodate pedestrians, but an observation deck could eventually be built to mitigate the loss of viewing opportunities. A similar concept was explored to some extent in the 2002 Quechee Gorge Bridge & Pedestrian Analysis Scoping Report- funded through VTrans and the Town of Hartford (Ideas #9 & 10)- but this alternative was focused on a separate pedestrian bridge.
- Comments from Hartford PD and HCRS- not in favor of rails due to potential challenges associated with rescue operations and potential for increased post-secondary trauma. Comments from VTrans- need to know more about winter maintenance and long-term maintenance associated with netting. Recommend reaching out to Ithaca to determine how rescue operations and maintenance operations have gone post netting installation.
- Dubois & King will need to complete a more thorough analysis on the effectiveness of barriers.
- Wrap up/next steps:
 - At this time, the general consensus was that the preferred alternative was a vertical barrier.
 - Also proposed to consider the aesthetic analysis of barriers proposed from the pedestrian perspective, not the vehicle/driver perspective due to operating/safety concerns.
 - Need to look at more recent crash data.
 - Need to ensure permitting requirements associated with each proposed alternative is analyzed (i.e. NEPA, Historic Preservation). This will also be dependent on funding sources and whether or not work would be complete within the existing VTrans ROW for the proposed alternatives (i.e. if proposed alternative is in the State ROW and federal funds are used- 106 and 4F; if outside AOT ROW on recreation lands – subject to 6F).
- Need a full survey of the area and 1989 site plan.
- One to two mote meetings with this group to review and comments on findings and proposed recommendations.

10/12/16 Quechee Gorge Bridge Suicide Prevention Study Meeting: Review Draft Alternatives

Attending:

Jackie Cassino, PPAID

Michele Boomhower, PPAID

Chris Slesar, Environmental

Jesse Devlin, Hwy Safety & Design

Jon Kaplan, Bike/Ped

Judith Ehrlich, Historical & Archaeological Resources

J.B. McCarthy, Structures

Todd Law, Maintenance & Operations

Lucy Gibson, D&K (called in)

Robert Durfee, D&K (called in)

Agenda:

-Review existing conditions

-Review findings and observations

-Review alternative cross sections

-Review barrier alternatives

Discussion:

-Average of 1 death per year over the past 9 years, rate increase to 1.5 per year over the past 4 years

-Bridge stats:

- o Length 285'
- o AADT 8970 (2016 ATR count)
- o Current cross section: 12' travel lanes, 3' shoulders, sidewalk width 3.5' (no passing zone for length of bridge)- which does not meet ADA standards
- o Current bridge rail from 1973, aluminum 3'9" high- meets AASHTO standards but not VTrans
- o Vermont State Design Standards stipulate: Bridges to remain in place without treatment should have at least the width of the roadway approach travel way plus 2' clearance to face of rail on each side, and should be adequate for State legal loads without posted restrictions
- o Minimum lane width for rural principal arterials at 35 MPH or lower is 11'

-Crashes: 33 reported from 2010 to 2016

-Quechee Gorge State Park- Cliffs in close proximity to bridge protected by a 4' chain link fence, 2 recent known attempts, also charged with considering safety measures in the "surrounding area" as stipulated in the Transportation Bill

-Visitor Observations: D&K staff observed visitor over the Columbus Day weekend. General summary: large numbers, all abilities, ages, etc.. Many arrive by bus. Majority walk on both sidewalks to observe the Gorge from each side. Sidewalks are too narrow to accommodate pedestrian traffic, stroller, walk, or wheelchair passing.

-Recommendations:

- Sidewalks widened to 5’ over entire length to meet ADA guidelines and accommodate visitor traffic.
- Sidewalks provided on both sides of bridge (Visitors are likely to view gorge from both sides regardless of sidewalks in place. Too crowded with just one sidewalk.).
- 4 options presented to accommodate barrier and widened sidewalks
 - 1) Widen sidewalks; barrier mounted inside vehicle rail

Description	Sidewalk is reconstructed and widened to meet ADA standards by cantilevering a new reinforced concrete sidewalk. Vehicle rail is relocated or replaced on outside of sidewalk. Vertical barrier is mounted inside of vehicle rail. Pedestrian barrier re-installed or replaced in existing location. Stringer under sidewalk replaced with shallower beam to maintain existing curb reveal due to increased thickness of sidewalk. Existing travel lane and shoulder width is maintained.
Visual impact	Vertical balusters mounted inside of vehicle rail will limit ability to look down into gorge.
Cost (\$-\$\$\$\$)	(\$\$\$) Cost is moderate compared to other options due to need for new stringer, reconstruction of reinforced concrete
Advantages	-Avoids widening of floor beam and relocation of water line -Maintains existing traveled way width
Disadvantages	-Mounting of steel vertical barrier onto aluminum vehicle rail combines unlike metals, encourages corrosion -Likely to reduce live load rating to below HS 20 (at inventory)

- 2) Narrow travel way, barrier mounted inside vehicle rail

Description	Sidewalk is widened to meet ADA standards to the inside of the bridge, reducing the traveled way width to 13 feet (12 ft lanes/1 ft shoulders; could be re-striped to 11 ft lanes/2 ft shoulders). Pedestrian barrier is relocated to inside of sidewalk.
Visual impact	Vertical balusters mounted inside of vehicle rail will limit ability to look down into gorge.
Cost (\$-\$\$\$\$)	(\$\$) Cost is lowest compared to other options as new structural beams are not required, and sidewalk does not need to be reconstructed.
Advantages	Avoids widening of floor beam and relocation of water line
Disadvantages	-Mounting of steel vertical barrier onto aluminum vehicle rail combines unlike metals, encourages corrosion -Narrows traveled way width to less desired for snow removal -Likely to reduce live load rating to HS 20 (at inventory)

- 3) Widen bridge floor beams, barrier mounted outside vehicle rail

Description	Bridge floorbeams are widened to support new barrier. Pedestrian barrier remains in place. Sidewalk remains at current width. Travel lanes and shoulder width do not change. Vertical balusters are
--------------------	---

	mounted outside of vehicle rail. New steel stringer installed to support vertical barrier. Water line is relocated
Visual impact	Vertical barrier placement outside of vehicle barrier will limit how close viewers can be to look through rails.
Cost (\$-\$\$\$\$)	(\$\$\$\$) Cost is highest relative to other options due to new steel supports and water line relocation
Advantages	Maintains existing traveled way width
Disadvantages	-Mounting of steel vertical barrier onto aluminum vehicle rail combines unlike metals, encourages corrosion. -Likely to reduce live load rating to below HS 20 (at inventory). -Exposed traffic rails in front of barrier make it easier to climb, so a higher barrier may be advisable. -Maintains narrower sidewalk; will require a widened segment at the bridge's midpoint to meet ADA.

4) Narrow travel way, mount vehicle rail at edge of travel way, barrier mounted on sidewalk edge

Description	Sidewalk is widened to inside of bridge, reducing shoulder width to 1 foot. Vehicle rail is installed on inside edge of sidewalk. Bridge rail terminals will need to be installed on bridge approaches. Crosswalks will need to be relocated further from bridge. (Stairs are a possible mitigation as proposed in earlier study).
Visual impact	This is the lowest visual impact of these alternatives as viewers can be immediately next to the vertical rails, maximizing view angles.
Cost (\$-\$\$\$\$)	(\$\$\$) Cost is moderate compared to other options as new steel and bridge widening is not required
Advantages	-Avoids combination of unlike metals on bridge railing. -Allows best viewing opportunity for visitors Eliminates the need for seasonal installation of pedestrian barrier
Disadvantages	-Narrows traveled way width to less desired for snow removal -Bridge rail terminal between road and sidewalk required -Crosswalk relocation required -Likely to reduce live load rating to HS 20 (at inventory). -Vehicle barrier may result in tripping hazard for pedestrians

-Comments regarding above alternatives:

- o Typically, 11' travel lanes with 3' shoulders work throughout the state- need at least these widths for winter maintenance (14' clearance for plows)
- o As currently proposed Alternatives 2 and 4 are not an option as travel lanes- BUT majority present spoke in favor of Alternative 4 with reconfigured lane widths.
- o Considering a revised Alternative 4- Crosswalks would need to be moved. Also recommended adding a RRFB at both crosswalks to enhance crosswalk visibility.

- Considering a revised Alternative 4- Challenge identified in how to terminate bridge/traffic railing. South Royalton bridge given as an example. J.B. to follow up and send D&K plans for such an example.
- Considering a revised Alternative 4- Current width of aluminum bridge railing is 1'6"- which is wide. This would be replaced to accommodate VTrans standards- rail would be steel and more narrow- 8" post and 4" rail- may gain 6" of space.
- Considering a revised Alternative 4- Group preferred having steel baluster barrier (suicide prevention barrier) separate from the bridge/traffic railing). D&K will most likely recommend galvanized steel and pain for barrier and railing.
- At this time, no concerns from historic preservation perspective. Will need to be engaged in the public meeting process.

-Other barriers discussed:

- Nets- Still looking into for additional details. Thus far- challenges have been identified with maintenance (bridge itself as well as nets) and rescue/recovery operation.
- Mesh- Visually intrusive. Doesn't allow photography.
- Acrylic/Plexiglass- Typically used as a sound barrier- not suicide prevention. High cost- capital and maintenance. Needs to be designed for wind sheer.
- Chain link- Not compatible with historic structure. Aesthetically/visually intrusive.
- Steel balusters. Recommended by D&K. Allows viewing and photography. Used successfully on many bridges.

Next steps:

-D&K to revise alternatives based on feedback and send out to this internal group for review.

-Regarding Alternative 4- Challenge identified in how to terminate bridge/traffic railing. South Royalton bridge given as an example. J.B. to follow up and send D&K plans for such an example.

-Meetings- Next Technical Advisory Committee meeting Tuesday 11/8 from 1-2:30PM; Meeting with Municipal stakeholders 11/9; and Public Meeting 11/16.

**12/6/2106 Quechee Gorge Bridge – Suicide Prevention Study
Technical Advisory Committee Meeting #3**

Attending:

Jackie Cassino, PPAID

Lesley Porter, Forest, Parks, & Recreation

Kevin Marshia, Chief Highway Engineer

Jesse Devlin, Hwy Safety & Design

Judith Ehrlich, Historical & Archaeological Resources

J.B. McCarthy, Structures

Todd Law, Maintenance & Operations

Kyle Obenauer, Historical & Archaeological Resources

Lucy Gibson, D&K

Devin Coleman, DHCD

Whitney Husson, Hartford PD

Alan Beebe, Hartford Assistance Fire Chief

Scott Cooneey, Hartford Fire Chief

Meeting Agenda:

Project Update & Current Schedule

- ☐ Draft report due to VTrans mid-December
- ☐ Final report due to VTrans late December

Report on Public Meeting

- ☐ Good attendance, questions and discussion
- ☐ General openness to project, support for taking action, and preference for nets over barrier

Update on Alternatives

- 1) Non-Means restriction option will be modified to include lighting of bridge and parking area
- 2) Suicide prevention barrier (includes reconstruction of sidewalks to meet ADA)
- 3) Suicide prevention nets
- 4) Suicide prevention nets plus reconstruction of sidewalks to meet ADA
- 5) Temporary suicide prevention barrier: chain link fence. This alternative has been developed in response to public support for early action; but has not yet been presented to community.

Construction Cost Estimates Review

Maintenance and Operations Cost Analysis

- ☐ Discuss costs/risks of not implementing suicide prevention barrier, including public safety personnel, required police investigations, impacts to witnesses and local businesses, etc.
- ☐ Review updated information received from Cornell on net maintenance activities and costs
- ☐ Itemize and assign maintenance costs for town, state, others for each option

Discussion on implementation timelines and options

Discussion Draft Decision Matrix

Discussion:

- Maintenance and bridge inspection- option to contract out for this work- that will be an added expense to be accounted for- separate funding sources- can't lump together in once contract. The snooper truck currently used must have vertical access to the railing- the currently sidewalk configuration (at 3.5') is already a challenge and is the maximum width that this truck can accommodate. The same is true for current truck utilized in recovery/rescue operations.
- JB McCarthy noted- I think one option that should be included in this study is to include the installation of a permanent catwalk underneath this bridge. This could serve several purposes from inspection to maintenance and also possibly be of used for retrieval. It would also eliminate the need for any special inspection services while not precluding and type of barriers on top for suicide prevention. VTrans did install a catwalk on the 1200 ft. long I91 bridge in Hartford for the same purpose.
- Cost-Benefit Analysis. The Value of Statistical Life (VSL) rate discussed needs further analysis as VTrans utilizes a different rate than the most recent USDOT calculation of \$9.4 million (\$5.2-\$13 million range) identified.
 - VTrans Traffic Safety Engineer utilizes the 2007 Highway Safety Manual method utilized \$1.4 million for the VSL
 - FHWA's Roger Thompson is looking into and will get back to us
- The estimated \$20,000 cost to the Town for each recovery/rescue operations may be on the low side as it does not include post-incident costs (i.e. paperwork, medical examiner costs, etc.). The Town is working on quantifying this estimate.
- Clarification on netting life-cycle. Ithaca initially prepared a maintenance plan which stipulated that the nets would be replaced every 5 years. The consultant has since learned that the life cycle estimate of the nets is 25 years. Company utilized is Pike Company- Albany, NY. The fixed net system adds \$40,000 every other year for 6 bridges in inspection and maintenance costs.
- Based on information from the District and Structures Staff, the estimated yearly maintenance costs currently associated with the bridge are as follows (Note: normal activities such as sweeping and washing are done on multiple bridges in a day – so these estimates are conservative):

➤ Pedestrian Fence, Install and Remove	\$5000
➤ Sweeping	\$700
➤ Washing	\$2500
➤ Inspection/TC/Safety*	\$4000 ¹
➤ TOTAL	\$12,200
- Project timeline discussion. It is possible this project could qualify for the Accelerated Bridge Program. NEPA process will need to be accounted for. Question regarding whether or not federal funding could be used for this project- it has in other states. Netting is manufactured in NY State but product itself is produced outside of the USA- will need to touch based with FHWA as to whether or not a waiver could be applied.
 - ABP project delivery- minimum 2 years
 - Conventional project delivery- minimum 5 years

Action Items:

- Refine Decision Matrix
- Update vital statistics regarding suicides from the VT Department of Health

¹ Via Pam Thurber email 12/12/16- The District has the cost associated with traffic control, working over water, etc. (i.e. cost for district assistance). That leaves the cost of the servi-lift, its operator, and the inspection team. We don't break down costs by inspection so we've made a few assumptions. Let's say an inspection takes 8 hours and rounding costs up and not including the inspectors' truck usage, I'd say an inspection costs about \$2,500 - \$3,000. At this point an inspection is done once every 24 months but, depending on conditions or extenuating reasons (like the Minnesota collapse), it could be done annually. Please note, this is VTrans' cost using our personnel and equipment. If we were to contract it out the cost would be much higher.

- Feedback needed from the following:
 - Department of Public Service (as stipulated in the T-Bill)- General information and report once draft is ready for review
 - DHCD- Tourism and Marketing- same as above
 - Army Corps and Department of Forests, Parks, and Recreations- Discuss chain link fence along the gorge- permitting, cost, etc.
 - FHWA- General information and report once draft is ready for review. Discuss federal funding eligibility and made in the USA waiver.
 - VTrans Structures and District- cost estimates for maintenance, inspections, and catwalk
 - VTrans Highway Safety- reconcile VSL
 - VTrans Environmental-permitting



- Randolph, VT 05060 (802) 728-3376
- Bedford, NH 03110 (603) 637-1043
- × S. Burlington, VT 05403 (802) 878-7661
- Laconia, NH 03246 (603) 524-1166

Engineering | Planning | Development | Management

PROJECT 622924 - Quechee Gorge Bridge
 SHEET NO. 1 OF 2
 CALCULATED BY: MQ DATE: 23-Nov-16
 CHECKED BY: _____ DATE: _____
 SCALE: _____

**Quechee Gorge Bridge Means Restriction: Barrier
 Engineer's Opinion of Probable Construction Cost**

ITEM NO.	DESCRIPTION		UNIT	QTY	UNIT PRICE	AMOUNT
VTRANS PARTICIPATING ITEMS						
406.25	BITUMINOUS CONCRETE PAVEMENT		TONS	15	\$250.00	\$3,750.00
507.11	REINFORCING STEEL, LEVEL I		LB	875	\$2.00	\$1,750.00
507.16	DRILLING AND GROUTING DOWELS		LF	570	\$21.65	\$12,339.36
514.10	WATER REPELLENT, SILANE		GAL	55	\$81.46	\$4,480.30
519.20	SHEET MEMBRANE WATERPROOFING, TORCH APPLIED		SY	175	\$34.02	\$5,953.50
525.10	REMOVAL OF EXISTING BRIDGE RAILING		LF	1140	\$2.32	\$2,644.80
525.34	BRIDGE RAILING, GALVANIZED 3 RAIL BOX BEAM		LF	570	\$180.97	\$103,152.90
529.10	REMOVAL OF BRIDGE PAVEMENT		SY	175	\$25.00	\$4,375.00
529.25	REMOVAL OF CONCRETE OR MASONRY (existing sidewalk)		CY	100	\$221.98	\$22,198.00
541.22	CONCRETE CLASS A		CY	150	\$1,200.00	\$180,000.00
580.12	REPAIR OF CONCRETE SUPERSTRUCTURE SURFACE, CLASS III		CY	8	\$1,399.09	\$11,192.72
580.16	SURFACE PREPARATION FOR MEMBRANE		SF	875	\$0.47	\$411.25
580.17	RAPID SETTING CONCRETE REPAIR MATERIAL		CF	220	\$175.00	\$38,500.00
604.40	CHANGING ELEVATION OF DROP INLETS, CATCH BASINS, OR MANHOLES		EACH	12	\$550.00	\$6,600.00
604.412	REHAB. DROP INLETS, CATCH BASINS, OR MANHOLES, CLASS I		EACH	12	\$1,200.00	\$14,400.00
616.22	GRANITE BRIDGE CURB		LF	700	\$70.00	\$49,000.00
621.725	GUARDRAIL APPROACH SECTION, GALVANIZED 3 RAIL BOX BEAM		EACH	4	\$5,928.32	\$23,713.28
621.90	TEMPORARY TRAFFIC BARRIER		LF	385	\$31.96	\$12,304.60
621.95	REMOVE AND RESET TEMPORARY TRAFFIC BARRIER		LF	385	\$11.22	\$4,319.70
630.15	FLAGGERS		HR	600	\$32.82	\$19,692.00
631.10	FIELD OFFICE, ENGINEERS		U	1	\$17,204.00	\$17,204.00
631.16	TESTING EQUIPMENT, CONCRETE		U	1	\$873.00	\$873.00
635.11	MOBILIZATION/DEMOBILIZATION		U	1	\$80,000.00	\$80,000.00
641.10	TRAFFIC CONTROL		U	1	\$75,000.00	\$75,000.00
675.33	TUBULAR STEEL SIGN POST		LB	7000	\$2.46	\$17,220.00
678.40	TEMPORARY TRAFFIC SIGNAL SYSTEM		U	1	\$30,000.00	\$30,000.00
900.620	SPECIAL PROVISION	SWING STAGING	EACH	1	\$7,550.00	\$7,550.00
900.6201	SPECIAL PROVISION	DECORATIVE STREET LIGHTS	EACH	12	\$10,000.00	\$120,000.00
900.6400	SPECIAL PROVISION	PEDESTRIAN MEANS RESTRICTION - BARRIER	LF	600	\$215.00	\$129,000.00
900.6402	SPECIAL PROVISION	CHAIN-LINK FENCE, VINYL COATED, 8 FEET, CLIFF APPROACH	LF	600	\$26.00	\$15,600.00
VTRANS PARTICIPATING SUBTOTAL						\$1,013,224.41



- Randolph, VT 05060 (802) 728-3376
 - Bedford, NH 03110 (603) 637-1043
 - × S. Burlington, VT 05403 (802) 878-7661
 - Laconia, NH 03246 (603) 524-1166
- Planning | Development | Management

PROJECT 622924 - Quechee Gorge Bridge
 SHEET NO. 2 OF 2
 CALCULATED BY: MQ DATE: 23-Nov-16
 CHECKED BY: _____ DATE: _____
 SCALE: _____

**Quechee Gorge Bridge Means Restriction: Barrier
 Engineer's Opinion of Probable Construction Cost**

VTRANS PARTICIPATING SUBTOTAL	\$1,013,224.41
20% Contingency	\$202,644.88

Construction:

Estimated Total Construction	\$1,215,870.00
Construction Admin. (~10%)	\$120,000.00
Total Construction	\$1,335,870.00

Preliminary Engineering:

Engineering Study (~10%)	\$120,000.00
Eng. Design & Permitting (~15%)	\$185,000.00
Bid Phase Admin. (~5%)	\$70,000.00
Total Prelim. Engineering	\$375,000.00

Total Budget for Project	\$1,710,870.00
---------------------------------	-----------------------

Note:

In providing opinions of probable construction cost, the Client understands that D&K has no control over the cost or availability of labor, equipment or materials, or over market conditions or the Contractor's method of pricing, and that our Opinion of Probable Construction Costs are made on the basis of our professional judgment and experience. D&K makes no warranty, expressed or implied, that the bids or the negotiated cost of the Work will not vary from the Opinion of Probable Construction Cost provided herein.



- Randolph, VT 05060 (802) 728-3376
- Bedford, NH 03110 (603) 637-1043
- × S. Burlington, VT 05403 (802) 878-7661
- Laconia, NH 03246 (603) 524-1166

Engineering | Planning | Development | Management

PROJECT 622924 - Quechee Gorge Bridge
 SHEET NO. 1 OF 1
 CALCULATED BY: MQ DATE: 23-Nov-16
 CHECKED BY: _____ DATE: _____
 SCALE: _____

**Quechee Gorge Bridge Means Restriction: Netting
 Engineer's Opinion of Probable Construction Cost**

ITEM NO.	DESCRIPTION	UNIT	QTY	UNIT PRICE	AMOUNT	
VTRANS PARTICIPATING ITEMS						
900.645	SPECIAL PROVISION	PEDESTRIAN MEANS RESTRICTION - NETTING*	U	1	\$1,210,000.00	\$1,210,000.00
900.6402	SPECIAL PROVISION	CHAIN-LINK FENCE, VINYL COATED, 8 FEET, CLIFF APPROACH	LF	600	\$26.00	\$15,600.00

* Item includes: wire mesh net systems (both sides of bridge & access points near abutments), support structure, camera & alarming system, lighting, traffic control, mobilization, flaggers, temporary traffic signals, temporary traffic barrier

VTRANS PARTICIPATING SUBTOTAL	\$1,225,600.00
20% Contingency	\$245,120.00

<u>Construction:</u>	
Estimated Total Construction	\$1,470,720.00
Construction Admin.	
Total Construction	\$1,470,720.00

<u>Preliminary Engineering:</u>	
Engineering Study	\$150,000.00
Eng. Design & Permitting	\$220,000.00
Bid Phase Admin.	\$80,000.00
Total Prelim. Engineering	\$450,000.00



- Randolph, VT 05060 (802) 728-3376
- Bedford, NH 03110 (603) 637-1043
- × S. Burlington, VT 05403 (802) 878-7661
- Laconia, NH 03246 (603) 524-1166

Engineering | Planning | Development | Management

PROJECT 622924 - Quechee Gorge Bridge
 SHEET NO. 1 OF 1
 CALCULATED BY: MQ DATE: 05-Dec-16
 CHECKED BY: _____ DATE: _____
 SCALE: _____

**Quechee Gorge Bridge Means Restriction: Temporary Welded Wire Mesh Barrier
 Engineer's Opinion of Probable Construction Cost**

ITEM NO.	DESCRIPTION	UNIT	QTY	UNIT PRICE	AMOUNT	
VTRANS PARTICIPATING ITEMS						
620.22	BRACING ASSEMBLY FOR CHAIN-LINK FENCE, 8 FEET	EACH	8	\$214.14	\$1,713.12	
621.90	TEMPORARY TRAFFIC BARRIER	LF	385	\$31.96	\$12,304.60	
621.95	REMOVE AND RESET TEMPORARY TRAFFIC BARRIER	LF	385	\$11.22	\$4,319.70	
630.15	FLAGGERS	HR	200	\$32.82	\$6,564.00	
631.10	FIELD OFFICE, ENGINEERS	U	1	\$17,204.00	\$17,204.00	
635.11	MOBILIZATION/DEMOBILIZATION	U	1	\$18,000.00	\$18,000.00	
641.10	TRAFFIC CONTROL	U	1	\$50,000.00	\$50,000.00	
678.40	TEMPORARY TRAFFIC SIGNAL SYSTEM	U	1	\$30,000.00	\$30,000.00	
900.610	SPECIAL PROVISION	RS MEANS CREW B-80C	DAY	10	\$1,521.26	\$15,212.60
900.6403	SPECIAL PROVISION	WELDED WIRE MESH FENCE, VINYL COATED, 8 FEET, BRIDGE MOUNTED	LF	600	\$52.00	\$31,200.00
VTRANS PARTICIPATING SUBTOTAL					\$186,518.02	
20% Contingency					\$37,303.60	
Construction:						
Estimated Total Construction					\$223,821.62	
Construction Admin.					\$20,000.00	
Total Construction					\$243,821.62	
Preliminary Engineering:						
Engineering Study					\$20,000.00	
Eng. Design & Permitting					\$20,000.00	
Bid Phase Admin.					\$10,000.00	
Total Prelim. Engineering					\$50,000.00	
Total Budget for Project					\$293,830.00	

Note:

In providing opinions of probable construction cost, the Client understands that D&K has no control over the cost or availability of labor, equipment or materials, or over market conditions or the Contractor's method of pricing, and that our Opinion of Probable Construction Costs are made on the basis of our professional judgment and experience. D&K makes no warranty, expressed or implied, that the bids or the negotiated cost of the Work will not vary from the Opinion of Probable Construction Cost provided herein.